



■ Made
■ in
■ Germany



FRANKEN

Hard-Cut

高硬度鋼用ボール/ラジラス エンドミル
High Performance End Mills for Hardened materials



100年以上に及ぶ高精度と革新性の追求 More than 100 years of precision and innovation.

フランケン社は創業時よりミリング工具を専門に開発・製造し、エムゲ・フランケン ブランドの一翼を担ってまいりました。超硬、ハイス、PCD / CBN、スローアウェイカッターとインサートによって構成される強力な製品ラインナップは、高精度と革新性という言葉によって広く知られています。

ドイツ国内の工場では製造される製品群は、標準的な各種エンドミルを中心に高精度特殊プロファイルカッターまで多岐に渡っています。この幅広い工具と工具材種のラインナップ、高い技術力と品質、他の追随を許さない高精度をもって、フランケン社の製品はあらゆる高品質なご要求に対する解決策となるでしょう。

さらに、ミリングツールに加え、クランピングシステムとホールディングツールを併せたトータルソリューションを提供しています。

Ever since its foundation FRANKEN as part of the EMUGE-FRANKEN company association has been developing and manufacturing milling tools. The wide range of end mills of solid carbide and HSS as well as PCD and CBN inserts or milling cutters with indexable inserts is characterised by precision and innovation.

The production in our German manufacturing plant in Rückersdorf includes standard end mills and bore cutters as well as highly precise special form and profile milling tools. With its large variety of tool types and cutting materials, the consistently high standards and uncompromising precision, our product range of milling cutters meets even the highest quality requirements.

In addition to our selection of milling tools, we also offer a comprehensive range of clamping systems, tool holders and accessories.





フランケン ハードカット ボール/ラジラス エンドミルは高硬度鋼の加工に特化したハイパフォーマンスエンドミルシリーズです。このたび最大 16 x d₁ までの長さのストレートネックタイプがラインナップに追加になり、シリーズが刷新されました。極めて厳しい公差と高硬度鋼に最適化された刃先設計で、様々な産業向けの高精度3D金型の高効率加工において最高のパフォーマンスを発揮致します。

極めて高い耐摩耗性を持つ超硬母材と最新のPVDコーティングテクノロジーにより、フランケン ハードカットはハードミリングにおける特別な存在となるでしょう。

技術特性：

- 高精度を突きつめた極めて厳しいR公差を採用
- 公差 h4 円筒シャンクを採用し、高い回転振れ精度を実現
- 高硬度鋼専用に設計された切刃ジオメトリ
- 最適化された独自のチゼル設計
- 複数のストレートネック長 (最大 16 x d₁) を標準ラインナップ
- ハイフィードを可能にする多刃タイプも
- 高硬度鋼加工専用の超硬母材
- 最新のPVDコーティングテクノロジー

メインとなるアプリケーション：

- HRC66 までの高硬度鋼の加工
- 荒加工、中仕上げ加工、仕上げ加工と HSC高速仕上げ加工

FRANKEN's Hard-Cut ball nose and torus end mills are high-performance tools for the machining of hardened materials.

A wide range of dimensions with relieved neck and lengths of up to 16 x d₁ has been added to the product line. Very tight tolerances and a sophisticated cutting edge geometry enable the reliable production of high-precision 3D moulds, dies as well as moulding and embossing punches with highest performance.

An extremely wear-resistant carbide, combined with a modern high-performance PVD coating, make FRANKEN Hard-Cut end mills the specialists when it comes to hard milling.

Characteristics:

- Very tight radius tolerances for highest accuracies on the component
- Highly precise straight shanks with tolerance h4 enable high runout accuracy
- Special cutting edge geometry for hard machining
- Optimised chisel edge geometry
- Various relieved neck lengths (up to 16 x d₁) available from stock
- High number of flutes provides high feed rates
- Adapted carbide substrate for hardened materials
- Modern high-performance PVD coating

Main feature:

- Machining of hard materials up to 66 HRC
- Suitable for roughing, pre-finishing, finishing and HSC-finishing

目次

	ページ
プロダクトファインダー	4 - 6
超硬ボールエンドミル	8 - 29
超硬ラジラスエンドミル	30 - 47
コールドエアノズル	48 - 50

Content

	Page
Product finder	4 - 6
Solid carbide ball nose end mills	8 - 29
Solid carbide torus end mills	30 - 47
Cold-air nozzle and accessories	48 - 50

プロダクトファインダー

Product finder

注記：
各被削材に対する適用性は以下の記号で表されています：

■ = 最適
□ = 適用可能

Please note:
The suitability of the solid carbide ball nose and torus end mills is indicated as follows:

■ = very suitable
□ = suitable

適用範囲 - 被削材 Applications - material		引張り強さ Tensile strength	材種例(DIN他) Material examples	材種例(JIS他) Material examples		
P	鋼 1.1 冷間押し鋼 機械構造用炭素鋼 快削鋼	Steel materials Cold-extrusion steels, Construction steels, Free-cutting steels, etc.	≤ 600 N/mm ²	Cq15 S235JR (S137-2) 10SPb20	SPC, SPH, SS400, STKM, SUM22, SWRCH, SWRM	
	2.1 機械構造用炭素鋼 浸炭鋼 鋳鋼	Construction steels, Case-hardened steels, Steel castings, etc.	≤ 800 N/mm ²	E360 (St70-2) 16MnCr5 GS-25CrMo4	S35C, S45C, SCr415H, SCMn, SMn438, SUM24L	
	3.1 浸炭鋼 熱処理鋼 冷間鍛造鋼	Case-hardened steels, Heat-treatable steels, Cold work steels, etc.	≤ 1000 N/mm ²	20MoCr3 42CrMo4 102Cr6	SACM, SCM415H, SCM440H, SCMn, SCPH, SCr440H, SUJ2	
	4.1 熱処理鋼 冷間鍛造鋼 窒化鋼	Heat-treatable steels, Cold work steels, Nitriding steels, etc.	≤ 1200 N/mm ²	50CrMo4 X45NiCrMo4 31CrMo12	SCM445H, SKH, SKS, SKT, SUP	
	5.1 高合金鋼 合金工具鋼(冷間金型用) 合金工具鋼(熱間金型用)	High-alloyed steels, Cold work steels, Hot work steels, etc.	≤ 1400 N/mm ²	X38CrMoV5-3 X100CrMoV8-1-1 X40CrMoV5-1	SKD12, SKD61, SKT, SUH, SKH	
	M	ステンレス 1.1 フェライト、マルテンサイト	Stainless steel materials Ferritic, martensitic	≤ 950 N/mm ²	X2CrTi12	SCS, SUS420J2, SUS403
2.1 オーステナイト		Austenitic	≤ 950 N/mm ²	X6CrNiMoTi17-12-2	SCS, SUH, SUS304, SUS316	
3.1 オーステナイト/フェライト 二相系、析出硬化系		Austenitic-ferritic (Duplex)	≤ 1100 N/mm ²	X2CrNiMoN22-5-3	SUS329J3L, SUS3630	
4.1 オーステナイト/フェライト 二相系、析出硬化系		Austenitic-ferritic heat-resistant (Super Duplex)	≤ 1250 N/mm ²	X2CrNiMoN25-7-4	SUS329J4L, SCS14A, 15-5PH	
K	鋳鉄 1.1 ねずみ鋳鉄	Cast materials Cast iron with lamellar graphite (GJL)	100-250 N/mm ² 250-450 N/mm ²	EN-GJL-200 (GG20) EN-GJL-300 (GG30)	FC200 FC300	
	2.1 ダクタイル鋳鉄	Cast iron with nodular graphite (GJS)	350-500 N/mm ² 500-900 N/mm ²	EN-GJS-400-15 (GGG40) EN-GJS-700-2 (GGG70)	FCD400 FCD700	
	3.1 ハミキュラー鋳鉄	Cast iron with vermicular graphite (GJV)	300-400 N/mm ² 400-500 N/mm ²	GJV 300 GJV 450	FCV300 FCV400	
	4.1 可鍛鋳鉄	Malleable cast iron (GTMW, GTMB)	250-500 N/mm ² 500-800 N/mm ²	EN-GJMW-350-4 (GTW-35) EN-GJMB-450-6 (GTS-45)	FCMW330 FCMW370	
	N	非鉄 1.1 アルミニウム合金	Non-ferrous materials Aluminium alloys	≤ 200 N/mm ² ≤ 350 N/mm ² ≤ 550 N/mm ²	EN AW-AlMn1 EN AW-AlMgSi EN AW-AlZn5Mg3Cu	A1050, A3030 A5052, A6061 A7075
		1.2 アルミニウム合金 展伸材	Wrought aluminium alloys	Si ≤ 7%	EN AC-AlMg5	ADC5, AC7A
1.3		Aluminium cast alloys	7% < Si ≤ 12%	EN AC-AISi9Cu3	ADC11, ADC12, AC2A	
1.4		Aluminium cast alloys	12% < Si ≤ 17%	GD-AISi17Cu4FeMg	ADC14	
1.5 アルミニウム合金 鋳物		Aluminium cast alloys				
1.6		Aluminium cast alloys				
S	銅合金 2.1 純銅、低合金銅	Copper alloys Pure copper, low-alloyed copper	≤ 400 N/mm ²	E-Cu 57	純銅, C2400	
	2.2 黄銅	Copper-zinc alloys (brass, long-chipping)	≤ 550 N/mm ²	CuZn37 (Ms63)	C2720, C2801	
	2.3 快削黄銅	Copper-zinc alloys (brass, short-chipping)	≤ 550 N/mm ²	CuZn36Pb3 (Ms58)	C3560, C3710	
	2.4 アルミ青銅	Copper-aluminium alloys (alu bronze, long-chipping)	≤ 800 N/mm ²	CuAl10Ni5Fe4	C5210, C6280	
	2.5 青銅	Copper-tin alloys (tin bronze, long-chipping)	≤ 700 N/mm ²	CuSn8P	LCB3	
	2.6 快削青銅	Copper-tin alloys (tin bronze, short-chipping)	≤ 400 N/mm ²	CuSn7 ZnPb (Rg7)	BC3	
	2.7 特殊銅合金	Special copper alloys	≤ 600 N/mm ² ≤ 1400 N/mm ²	(AMPCO® 8) (AMPCO® 45)		
	3.1 マグネシウム合金	Magnesium alloys Magnesium wrought alloys	≤ 500 N/mm ²	MgAl6Zn		
	3.2 マグネシウム合金鋳物	Magnesium cast alloys	≤ 500 N/mm ²	EN-MCMgAl9Zn1	MC2A, MD1A	
	H	合成樹脂 4.1 熱硬化性樹脂	Synthetics Duroplastics (short-chipping)		Bakelit, Perinax	
4.2 熱可塑性樹脂		Thermoplastics (long-chipping)		PMMA, POM, PVC		
4.3 繊維強化樹脂(繊維含有量<30%)		Fibre-reinforced synthetics (fibre content ≤ 30%)		GFK, CFK, AFK		
4.4 繊維強化樹脂(繊維含有量>30%)		Fibre-reinforced synthetics (fibre content > 30%)		GFK, CFK, AFK		
5.1 特殊材料		Special materials Graphite		C 8000		
5.2 タングステン-銅合金		Tungsten-copper alloys		W-Cu 80/20		
5.3 複合材料		Composite materials		Hyllite, Alucobond		
耐熱合金 1.1 チタン合金		Special materials Titanium alloys	≤ 450 N/mm ² ≤ 900 N/mm ² ≤ 1250 N/mm ²	Ti1 TiAl6V4 TiAl4Mo4Sn2	純チタン Ti-6Al-4V TiAl4Mo4Sn2	
1.2 純チタン		Pure titanium				
1.3 チタン合金		Titanium alloys				
2.1 ニッケル合金、コバルト合金、鉄合金	Nickel alloys, cobalt alloys and iron alloys					
2.2 純ニッケル	Pure nickel	≤ 600 N/mm ²	Ni 99.6	純ニッケル		
2.3 ニッケル合金	Nickel-base alloys	≤ 1000 N/mm ² ≤ 1600 N/mm ²	Monel 400 Inconel 718	モネル 400, ハステロイ B インコネル 718		
2.4 コバルト合金	Cobalt-base alloys	≤ 1000 N/mm ² ≤ 1600 N/mm ²	Udimet 605 Haynes 25	Udimet 605 ヘインズ 25		
2.5 鉄合金	Iron-base alloys	≤ 1500 N/mm ²	Incoloy 800	インコロイ 800		
H	高硬度鋼 1.1 高強度鋼、高硬度鋼、高硬度鋳鉄	Hard materials High strength steels, hardened steels, hard castings	44 - 50 HRC 50 - 55 HRC 55 - 60 HRC 60 - 63 HRC 63 - 66 HRC	Weldox 1100 Hardox 550 Armax 600T Ferro-Titanit HSSE	SKT4 ハードックス550 SKD61 SKD11 高速度鋼	

超硬ソリッド ボールエンドミル
Solid carbide ball nose end mills

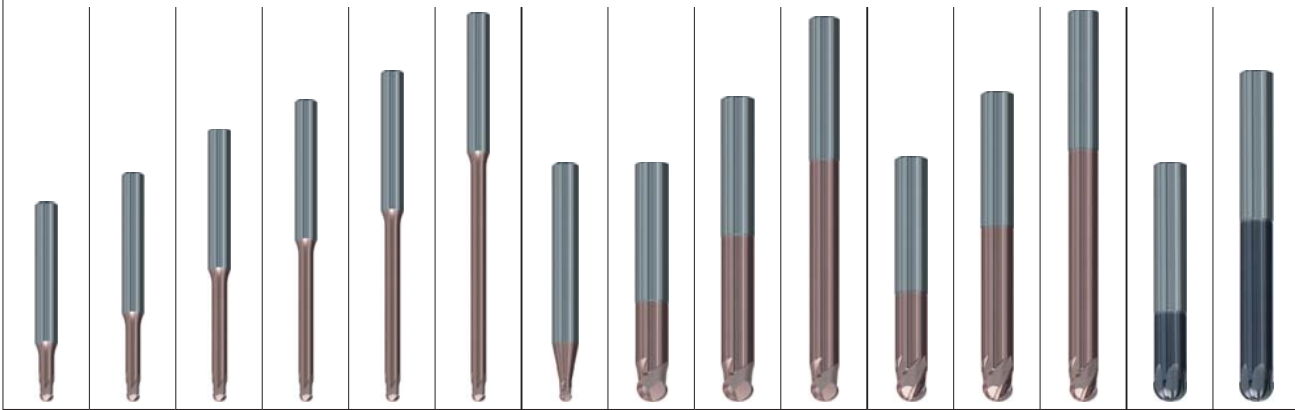

高硬度鋼

H

3 x d ₁	5 x d ₁	8 x d ₁	10 x d ₁	12 x d ₁	16 x d ₁	1,5 x d ₁	3 x d ₁	5 x d ₁	8 x d ₁	3 x d ₁	5 x d ₁	8 x d ₁	-	-	l ₃
ø0,4-6mm	ø0,4-6mm	ø0,4-6mm	ø0,4-6mm	ø0,4-6mm	ø1-2mm	ø0,5-3mm	ø0,5-12mm	ø0,5-12mm	ø0,5-8mm	ø2-12mm	ø2-12mm	ø2-8mm	ø10-12mm	ø10-16mm	d ₁
2	2	2	2	2	2	2	2	2	2	4	4	4	6-8	6-8	Z (刃数)
3860A	3861A	3862A	3863A	3864A	3865A	3826A	3827A	3828A	3829A	3831A	3832A	3833A	2836A	2837A	
8	10	12	12	14	14	16	16	18	20	22	24	26	28	28	ページ/Page
9	11	13	13	15	15	17	17	19	21	23	25	27	29	29	v _c / f _z

<input type="checkbox"/>	<input type="checkbox"/>	<input type="checkbox"/>	<input type="checkbox"/>	<input type="checkbox"/>	<input type="checkbox"/>	<input type="checkbox"/>	<input type="checkbox"/>	<input type="checkbox"/>	<input type="checkbox"/>	<input type="checkbox"/>	<input type="checkbox"/>	<input type="checkbox"/>	<input type="checkbox"/>	<input type="checkbox"/>	<input type="checkbox"/>	1.1
<input type="checkbox"/>	<input type="checkbox"/>	<input type="checkbox"/>	<input type="checkbox"/>	<input type="checkbox"/>	<input type="checkbox"/>	<input type="checkbox"/>	<input type="checkbox"/>	<input type="checkbox"/>	<input type="checkbox"/>	<input type="checkbox"/>	<input type="checkbox"/>	<input type="checkbox"/>	<input type="checkbox"/>	<input type="checkbox"/>	<input type="checkbox"/>	2.1
<input checked="" type="checkbox"/>	<input checked="" type="checkbox"/>	<input checked="" type="checkbox"/>	<input checked="" type="checkbox"/>	<input checked="" type="checkbox"/>	<input checked="" type="checkbox"/>	<input checked="" type="checkbox"/>	<input checked="" type="checkbox"/>	<input checked="" type="checkbox"/>	<input checked="" type="checkbox"/>	<input checked="" type="checkbox"/>	<input checked="" type="checkbox"/>	<input checked="" type="checkbox"/>	<input checked="" type="checkbox"/>	<input type="checkbox"/>	<input type="checkbox"/>	3.1
<input checked="" type="checkbox"/>	<input checked="" type="checkbox"/>	<input checked="" type="checkbox"/>	<input checked="" type="checkbox"/>	<input checked="" type="checkbox"/>	<input checked="" type="checkbox"/>	<input checked="" type="checkbox"/>	<input checked="" type="checkbox"/>	<input checked="" type="checkbox"/>	<input checked="" type="checkbox"/>	<input checked="" type="checkbox"/>	<input checked="" type="checkbox"/>	<input checked="" type="checkbox"/>	<input checked="" type="checkbox"/>	<input type="checkbox"/>	<input type="checkbox"/>	4.1
<input checked="" type="checkbox"/>	<input checked="" type="checkbox"/>	<input checked="" type="checkbox"/>	<input checked="" type="checkbox"/>	<input checked="" type="checkbox"/>	<input checked="" type="checkbox"/>	<input checked="" type="checkbox"/>	<input checked="" type="checkbox"/>	<input checked="" type="checkbox"/>	<input checked="" type="checkbox"/>	<input checked="" type="checkbox"/>	<input checked="" type="checkbox"/>	<input checked="" type="checkbox"/>	<input checked="" type="checkbox"/>	<input type="checkbox"/>	<input type="checkbox"/>	5.1
																1.1
																2.1
																3.1
																4.1
<input checked="" type="checkbox"/>	<input checked="" type="checkbox"/>	<input checked="" type="checkbox"/>	<input checked="" type="checkbox"/>	<input checked="" type="checkbox"/>	<input checked="" type="checkbox"/>	<input checked="" type="checkbox"/>	<input checked="" type="checkbox"/>	<input checked="" type="checkbox"/>	<input checked="" type="checkbox"/>	<input checked="" type="checkbox"/>	<input checked="" type="checkbox"/>	<input checked="" type="checkbox"/>	<input checked="" type="checkbox"/>	<input checked="" type="checkbox"/>	<input checked="" type="checkbox"/>	1.1
<input checked="" type="checkbox"/>	<input checked="" type="checkbox"/>	<input checked="" type="checkbox"/>	<input checked="" type="checkbox"/>	<input checked="" type="checkbox"/>	<input checked="" type="checkbox"/>	<input checked="" type="checkbox"/>	<input checked="" type="checkbox"/>	<input checked="" type="checkbox"/>	<input checked="" type="checkbox"/>	<input checked="" type="checkbox"/>	<input checked="" type="checkbox"/>	<input checked="" type="checkbox"/>	<input checked="" type="checkbox"/>	<input checked="" type="checkbox"/>	<input checked="" type="checkbox"/>	1.2
<input checked="" type="checkbox"/>	<input checked="" type="checkbox"/>	<input checked="" type="checkbox"/>	<input checked="" type="checkbox"/>	<input checked="" type="checkbox"/>	<input checked="" type="checkbox"/>	<input checked="" type="checkbox"/>	<input checked="" type="checkbox"/>	<input checked="" type="checkbox"/>	<input checked="" type="checkbox"/>	<input checked="" type="checkbox"/>	<input checked="" type="checkbox"/>	<input checked="" type="checkbox"/>	<input checked="" type="checkbox"/>	<input checked="" type="checkbox"/>	<input checked="" type="checkbox"/>	2.1
<input checked="" type="checkbox"/>	<input checked="" type="checkbox"/>	<input checked="" type="checkbox"/>	<input checked="" type="checkbox"/>	<input checked="" type="checkbox"/>	<input checked="" type="checkbox"/>	<input checked="" type="checkbox"/>	<input checked="" type="checkbox"/>	<input checked="" type="checkbox"/>	<input checked="" type="checkbox"/>	<input checked="" type="checkbox"/>	<input checked="" type="checkbox"/>	<input checked="" type="checkbox"/>	<input checked="" type="checkbox"/>	<input checked="" type="checkbox"/>	<input checked="" type="checkbox"/>	2.2
<input checked="" type="checkbox"/>	<input checked="" type="checkbox"/>	<input checked="" type="checkbox"/>	<input checked="" type="checkbox"/>	<input checked="" type="checkbox"/>	<input checked="" type="checkbox"/>	<input checked="" type="checkbox"/>	<input checked="" type="checkbox"/>	<input checked="" type="checkbox"/>	<input checked="" type="checkbox"/>	<input checked="" type="checkbox"/>	<input checked="" type="checkbox"/>	<input checked="" type="checkbox"/>	<input checked="" type="checkbox"/>	<input checked="" type="checkbox"/>	<input checked="" type="checkbox"/>	3.1
<input checked="" type="checkbox"/>	<input checked="" type="checkbox"/>	<input checked="" type="checkbox"/>	<input checked="" type="checkbox"/>	<input checked="" type="checkbox"/>	<input checked="" type="checkbox"/>	<input checked="" type="checkbox"/>	<input checked="" type="checkbox"/>	<input checked="" type="checkbox"/>	<input checked="" type="checkbox"/>	<input checked="" type="checkbox"/>	<input checked="" type="checkbox"/>	<input checked="" type="checkbox"/>	<input checked="" type="checkbox"/>	<input checked="" type="checkbox"/>	<input checked="" type="checkbox"/>	3.2
<input checked="" type="checkbox"/>	<input checked="" type="checkbox"/>	<input checked="" type="checkbox"/>	<input checked="" type="checkbox"/>	<input checked="" type="checkbox"/>	<input checked="" type="checkbox"/>	<input checked="" type="checkbox"/>	<input checked="" type="checkbox"/>	<input checked="" type="checkbox"/>	<input checked="" type="checkbox"/>	<input checked="" type="checkbox"/>	<input checked="" type="checkbox"/>	<input checked="" type="checkbox"/>	<input checked="" type="checkbox"/>	<input checked="" type="checkbox"/>	<input checked="" type="checkbox"/>	4.1
<input checked="" type="checkbox"/>	<input checked="" type="checkbox"/>	<input checked="" type="checkbox"/>	<input checked="" type="checkbox"/>	<input checked="" type="checkbox"/>	<input checked="" type="checkbox"/>	<input checked="" type="checkbox"/>	<input checked="" type="checkbox"/>	<input checked="" type="checkbox"/>	<input checked="" type="checkbox"/>	<input checked="" type="checkbox"/>	<input checked="" type="checkbox"/>	<input checked="" type="checkbox"/>	<input checked="" type="checkbox"/>	<input checked="" type="checkbox"/>	<input checked="" type="checkbox"/>	4.2
																1.1
																1.2
																1.3
																1.4
																1.5
																1.6
																2.1
																2.2
													<input type="checkbox"/>	<input type="checkbox"/>		2.3
																2.4
																2.5
													<input type="checkbox"/>	<input type="checkbox"/>		2.6
																2.7
																2.8
																3.1
																3.2
																4.1
																4.2
																4.3
																4.4
																5.1
																5.2
																5.3
																1.1
													<input checked="" type="checkbox"/>	<input checked="" type="checkbox"/>		1.2
													<input checked="" type="checkbox"/>	<input checked="" type="checkbox"/>		1.3
																2.1
													<input checked="" type="checkbox"/>	<input checked="" type="checkbox"/>		2.2
													<input checked="" type="checkbox"/>	<input checked="" type="checkbox"/>		2.3
													<input checked="" type="checkbox"/>	<input checked="" type="checkbox"/>		2.4
													<input checked="" type="checkbox"/>	<input checked="" type="checkbox"/>		2.5
													<input checked="" type="checkbox"/>	<input checked="" type="checkbox"/>		2.6
<input checked="" type="checkbox"/>	<input checked="" type="checkbox"/>	<input checked="" type="checkbox"/>	<input checked="" type="checkbox"/>	<input checked="" type="checkbox"/>	<input checked="" type="checkbox"/>	<input checked="" type="checkbox"/>	<input checked="" type="checkbox"/>	<input checked="" type="checkbox"/>	<input checked="" type="checkbox"/>	<input checked="" type="checkbox"/>	<input checked="" type="checkbox"/>	<input checked="" type="checkbox"/>	<input checked="" type="checkbox"/>	<input checked="" type="checkbox"/>	<input checked="" type="checkbox"/>	1.1
<input checked="" type="checkbox"/>	<input checked="" type="checkbox"/>	<input checked="" type="checkbox"/>	<input checked="" type="checkbox"/>	<input checked="" type="checkbox"/>	<input checked="" type="checkbox"/>	<input checked="" type="checkbox"/>	<input checked="" type="checkbox"/>	<input checked="" type="checkbox"/>	<input checked="" type="checkbox"/>	<input checked="" type="checkbox"/>	<input checked="" type="checkbox"/>	<input checked="" type="checkbox"/>	<input checked="" type="checkbox"/>	<input checked="" type="checkbox"/>	<input checked="" type="checkbox"/>	1.2
<input checked="" type="checkbox"/>	<input checked="" type="checkbox"/>	<input checked="" type="checkbox"/>	<input checked="" type="checkbox"/>	<input checked="" type="checkbox"/>	<input checked="" type="checkbox"/>	<input checked="" type="checkbox"/>	<input checked="" type="checkbox"/>	<input checked="" type="checkbox"/>	<input checked="" type="checkbox"/>	<input checked="" type="checkbox"/>	<input checked="" type="checkbox"/>	<input checked="" type="checkbox"/>	<input checked="" type="checkbox"/>	<input checked="" type="checkbox"/>	<input checked="" type="checkbox"/>	1.3
<input checked="" type="checkbox"/>	<input checked="" type="checkbox"/>	<input checked="" type="checkbox"/>	<input checked="" type="checkbox"/>	<input checked="" type="checkbox"/>	<input checked="" type="checkbox"/>	<input checked="" type="checkbox"/>	<input checked="" type="checkbox"/>	<input checked="" type="checkbox"/>	<input checked="" type="checkbox"/>	<input checked="" type="checkbox"/>	<input checked="" type="checkbox"/>	<input checked="" type="checkbox"/>	<input checked="" type="checkbox"/>	<input checked="" type="checkbox"/>	<input checked="" type="checkbox"/>	1.4
<input checked="" type="checkbox"/>	<input checked="" type="checkbox"/>	<input checked="" type="checkbox"/>	<input checked="" type="checkbox"/>	<input checked="" type="checkbox"/>	<input checked="" type="checkbox"/>	<input checked="" type="checkbox"/>	<input checked="" type="checkbox"/>	<input checked="" type="checkbox"/>	<input checked="" type="checkbox"/>	<input checked="" type="checkbox"/>	<input checked="" type="checkbox"/>	<input checked="" type="checkbox"/>	<input checked="" type="checkbox"/>	<input checked="" type="checkbox"/>	<input checked="" type="checkbox"/>	1.5

超硬ソリッド ラジラスエンドミル
Solid carbide torus end mills

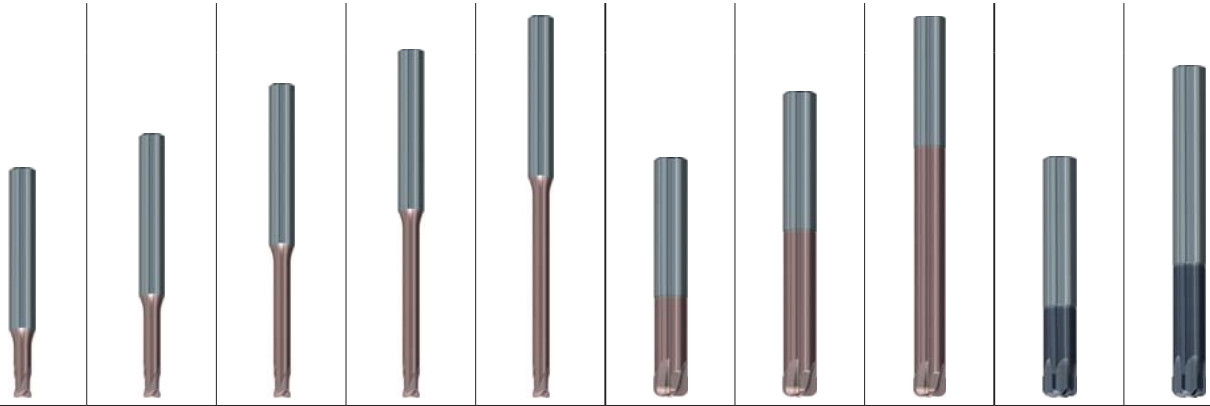

高硬度鋼

H

l_3	$3 \times d_1$	$5 \times d_1$	$8 \times d_1$	$10 \times d_1$	$12 \times d_1$	$3 \times d_1$	$5 \times d_1$	$8 \times d_1$	-	-
d_1	$\phi 0,5-6\text{mm}$	$\phi 0,5-6\text{mm}$	$\phi 0,5-6\text{mm}$	$\phi 0,5-6\text{mm}$	$\phi 0,5-6\text{mm}$	$\phi 2-16\text{mm}$	$\phi 2-16\text{mm}$	$\phi 2-8\text{mm}$	$\phi 10-12\text{mm}$	$\phi 10-16\text{mm}$
Z (刃数)	2	2	2	2	2	4	4	4	6-8	6-8
ページ/Page	30	32	34	36	38	40	42	44	46	46
v_c / f_z	31	33	35	37	39	41	43	45	47	47
P	1.1	<input type="checkbox"/>	<input type="checkbox"/>	<input type="checkbox"/>	<input type="checkbox"/>	<input checked="" type="checkbox"/>	<input checked="" type="checkbox"/>	<input checked="" type="checkbox"/>		
	2.1	<input type="checkbox"/>	<input type="checkbox"/>	<input type="checkbox"/>	<input type="checkbox"/>	<input checked="" type="checkbox"/>	<input checked="" type="checkbox"/>	<input checked="" type="checkbox"/>		
	3.1	<input checked="" type="checkbox"/>	<input checked="" type="checkbox"/>	<input checked="" type="checkbox"/>	<input checked="" type="checkbox"/>	<input checked="" type="checkbox"/>	<input checked="" type="checkbox"/>	<input checked="" type="checkbox"/>	<input type="checkbox"/>	<input type="checkbox"/>
	4.1	<input checked="" type="checkbox"/>	<input checked="" type="checkbox"/>	<input checked="" type="checkbox"/>	<input checked="" type="checkbox"/>	<input checked="" type="checkbox"/>	<input checked="" type="checkbox"/>	<input checked="" type="checkbox"/>	<input type="checkbox"/>	<input type="checkbox"/>
	5.1	<input checked="" type="checkbox"/>	<input checked="" type="checkbox"/>	<input checked="" type="checkbox"/>	<input checked="" type="checkbox"/>	<input checked="" type="checkbox"/>	<input checked="" type="checkbox"/>	<input checked="" type="checkbox"/>	<input type="checkbox"/>	<input type="checkbox"/>
M	1.1									
	2.1									
	3.1									
	4.1									
K	1.1	<input checked="" type="checkbox"/>	<input checked="" type="checkbox"/>	<input checked="" type="checkbox"/>	<input checked="" type="checkbox"/>	<input checked="" type="checkbox"/>	<input checked="" type="checkbox"/>	<input checked="" type="checkbox"/>	<input checked="" type="checkbox"/>	<input checked="" type="checkbox"/>
	1.2	<input checked="" type="checkbox"/>	<input checked="" type="checkbox"/>	<input checked="" type="checkbox"/>	<input checked="" type="checkbox"/>	<input checked="" type="checkbox"/>	<input checked="" type="checkbox"/>	<input checked="" type="checkbox"/>	<input checked="" type="checkbox"/>	<input checked="" type="checkbox"/>
	2.1	<input checked="" type="checkbox"/>	<input checked="" type="checkbox"/>	<input checked="" type="checkbox"/>	<input checked="" type="checkbox"/>	<input checked="" type="checkbox"/>	<input checked="" type="checkbox"/>	<input checked="" type="checkbox"/>	<input checked="" type="checkbox"/>	<input checked="" type="checkbox"/>
	2.2	<input checked="" type="checkbox"/>	<input checked="" type="checkbox"/>	<input checked="" type="checkbox"/>	<input checked="" type="checkbox"/>	<input checked="" type="checkbox"/>	<input checked="" type="checkbox"/>	<input checked="" type="checkbox"/>	<input checked="" type="checkbox"/>	<input checked="" type="checkbox"/>
	3.1	<input checked="" type="checkbox"/>	<input checked="" type="checkbox"/>	<input checked="" type="checkbox"/>	<input checked="" type="checkbox"/>	<input checked="" type="checkbox"/>	<input checked="" type="checkbox"/>	<input checked="" type="checkbox"/>	<input checked="" type="checkbox"/>	<input checked="" type="checkbox"/>
	3.2	<input checked="" type="checkbox"/>	<input checked="" type="checkbox"/>	<input checked="" type="checkbox"/>	<input checked="" type="checkbox"/>	<input checked="" type="checkbox"/>	<input checked="" type="checkbox"/>	<input checked="" type="checkbox"/>	<input checked="" type="checkbox"/>	<input checked="" type="checkbox"/>
	4.1	<input checked="" type="checkbox"/>	<input checked="" type="checkbox"/>	<input checked="" type="checkbox"/>	<input checked="" type="checkbox"/>	<input checked="" type="checkbox"/>	<input checked="" type="checkbox"/>	<input checked="" type="checkbox"/>	<input checked="" type="checkbox"/>	<input checked="" type="checkbox"/>
	4.2	<input checked="" type="checkbox"/>	<input checked="" type="checkbox"/>	<input checked="" type="checkbox"/>	<input checked="" type="checkbox"/>	<input checked="" type="checkbox"/>	<input checked="" type="checkbox"/>	<input checked="" type="checkbox"/>	<input checked="" type="checkbox"/>	<input checked="" type="checkbox"/>
	4.2	<input checked="" type="checkbox"/>	<input checked="" type="checkbox"/>	<input checked="" type="checkbox"/>	<input checked="" type="checkbox"/>	<input checked="" type="checkbox"/>	<input checked="" type="checkbox"/>	<input checked="" type="checkbox"/>	<input checked="" type="checkbox"/>	<input checked="" type="checkbox"/>
4.2	<input checked="" type="checkbox"/>	<input checked="" type="checkbox"/>	<input checked="" type="checkbox"/>	<input checked="" type="checkbox"/>	<input checked="" type="checkbox"/>	<input checked="" type="checkbox"/>	<input checked="" type="checkbox"/>	<input checked="" type="checkbox"/>	<input checked="" type="checkbox"/>	
N	1.1									
	1.2									
	1.3									
	1.4									
	1.5									
	1.6									
	2.1									
	2.2						<input type="checkbox"/>	<input type="checkbox"/>	<input type="checkbox"/>	
	2.3						<input checked="" type="checkbox"/>	<input checked="" type="checkbox"/>	<input checked="" type="checkbox"/>	<input type="checkbox"/>
	2.4						<input type="checkbox"/>	<input type="checkbox"/>	<input type="checkbox"/>	<input type="checkbox"/>
	2.5						<input type="checkbox"/>	<input type="checkbox"/>	<input type="checkbox"/>	
	2.6						<input checked="" type="checkbox"/>	<input checked="" type="checkbox"/>	<input checked="" type="checkbox"/>	<input type="checkbox"/>
	2.7						<input checked="" type="checkbox"/>	<input checked="" type="checkbox"/>	<input checked="" type="checkbox"/>	<input type="checkbox"/>
	2.8						<input checked="" type="checkbox"/>	<input checked="" type="checkbox"/>	<input checked="" type="checkbox"/>	
	3.1									
	3.2									
4.1										
4.2										
4.3										
4.4										
5.1										
5.2										
5.3										
S	1.1									
	1.2								<input checked="" type="checkbox"/>	<input checked="" type="checkbox"/>
	1.3								<input checked="" type="checkbox"/>	<input checked="" type="checkbox"/>
	2.1								<input checked="" type="checkbox"/>	<input checked="" type="checkbox"/>
	2.2								<input checked="" type="checkbox"/>	<input checked="" type="checkbox"/>
	2.3								<input checked="" type="checkbox"/>	<input checked="" type="checkbox"/>
	2.4								<input checked="" type="checkbox"/>	<input checked="" type="checkbox"/>
2.5								<input checked="" type="checkbox"/>	<input checked="" type="checkbox"/>	
2.6								<input checked="" type="checkbox"/>	<input checked="" type="checkbox"/>	
H	1.1	<input checked="" type="checkbox"/>	<input checked="" type="checkbox"/>	<input checked="" type="checkbox"/>	<input checked="" type="checkbox"/>	<input checked="" type="checkbox"/>	<input checked="" type="checkbox"/>	<input checked="" type="checkbox"/>	<input checked="" type="checkbox"/>	<input checked="" type="checkbox"/>
	1.2	<input checked="" type="checkbox"/>	<input checked="" type="checkbox"/>	<input checked="" type="checkbox"/>	<input checked="" type="checkbox"/>	<input checked="" type="checkbox"/>	<input checked="" type="checkbox"/>	<input checked="" type="checkbox"/>	<input checked="" type="checkbox"/>	<input checked="" type="checkbox"/>
	1.3	<input checked="" type="checkbox"/>	<input checked="" type="checkbox"/>	<input checked="" type="checkbox"/>	<input checked="" type="checkbox"/>	<input checked="" type="checkbox"/>	<input checked="" type="checkbox"/>	<input checked="" type="checkbox"/>	<input checked="" type="checkbox"/>	<input checked="" type="checkbox"/>
	1.4	<input checked="" type="checkbox"/>	<input checked="" type="checkbox"/>	<input checked="" type="checkbox"/>	<input checked="" type="checkbox"/>	<input checked="" type="checkbox"/>	<input checked="" type="checkbox"/>	<input checked="" type="checkbox"/>	<input checked="" type="checkbox"/>	<input checked="" type="checkbox"/>
	1.5	<input checked="" type="checkbox"/>	<input checked="" type="checkbox"/>	<input checked="" type="checkbox"/>	<input checked="" type="checkbox"/>	<input checked="" type="checkbox"/>	<input checked="" type="checkbox"/>	<input checked="" type="checkbox"/>	<input checked="" type="checkbox"/>	<input checked="" type="checkbox"/>

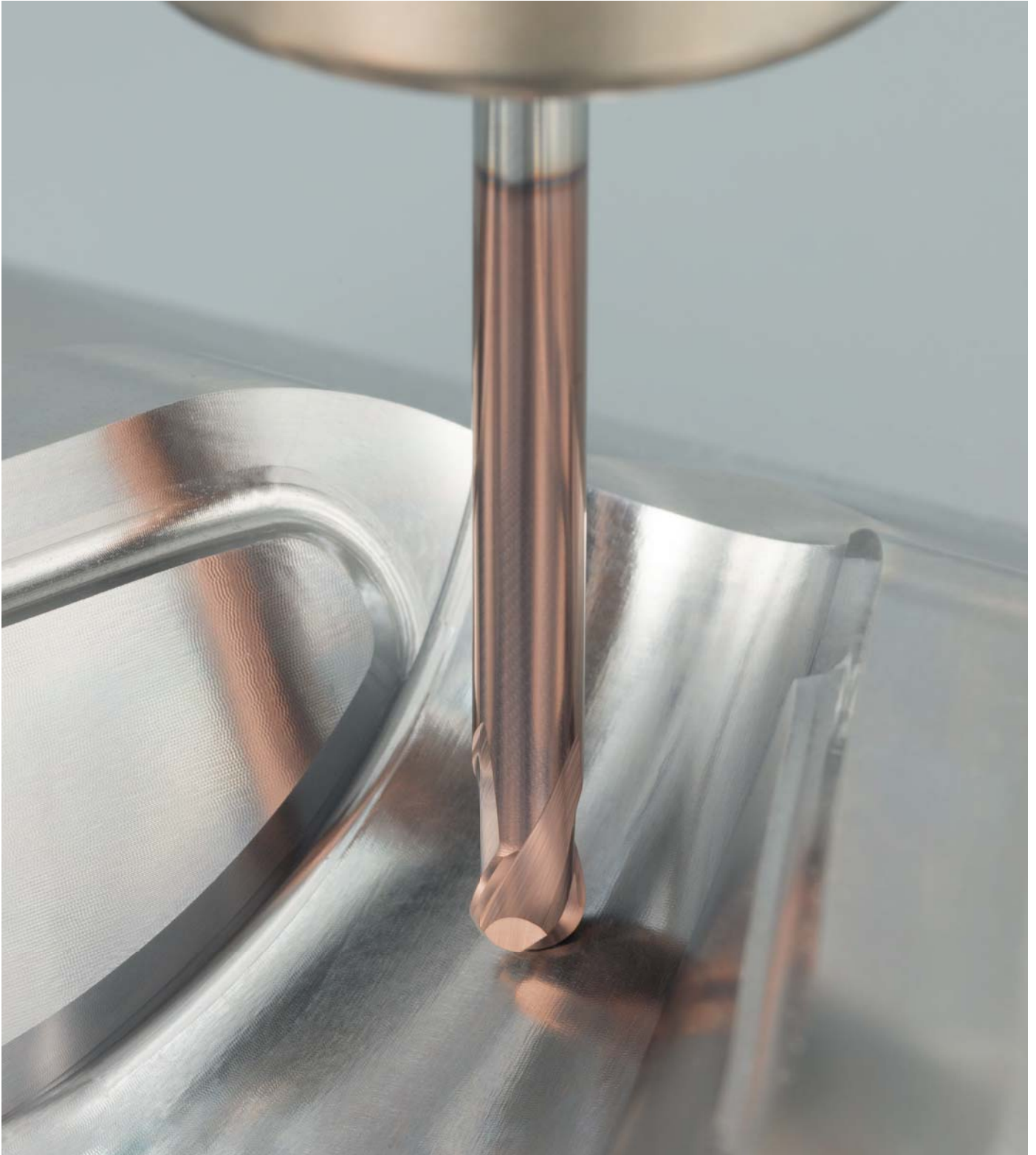
**24/7**高精度ツール · Precision Tools on
www.emuge-franken.com

カタログ内に表示されている QRコードを読み込むと、ツールの仕様、寸法、切削条件などの情報にダイレクトにアクセスできます。
(ただし英語/ドイツ語のみ)

また、アカウントを登録すれば 2D/3D データファイルや仕様情報などをダウンロード頂くことも可能です。

The QR code shown with the tools will take you directly to the respective articles in our web store where you can find comprehensive tool information and cutting data.

Registration provides you with additional product data and functions. These include standardised tool data (2D / 3D / characteristics), an order or quotation history and individual watch lists as well as other useful functions.

- ハイパフォーマンスツール
- 最大16 x d₁ までの 6種類のネック長さ
- より厳しいR公差
- h4 公差の高精度シャンク

- High performance tool
- 6 cylindrical neck lengths up to 16 x d₁ available
- High-precision radius
- Highly precise straight shank with tolerance h4

H

超硬

DIN 6535
HA
HB

30°

ボール

1-3°

≤ 66 HRC



new



高硬度鋼

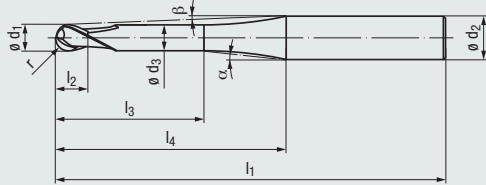
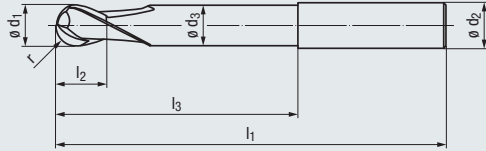

コーティング · Coating

アプリケーション - 被削材 (P4参照)

- 高硬度鋼加工用に新しく開発された特別な TIALN-コーティングを採用
- 立壁のあるキャビティの加工に
- HSC-高速仕上げ加工に最適

Applications – material (see page 4)

- Special TiAlN-coating for machining hardened materials
- For milling of cylindrical cavities
- Suitable for HSC finishing

TIALN

P	3.1-5.1	1.1-2.1
K	1.1-4.2	
H	1.1-1.5	

l₃ = 3 x d₁ - ショート · Short design

製品型番 · Order code

∅ d ₁	r	l ₂	l ₃	l ₁	∅ d ₃	l ₄	∅ d ₂ h4	α	β	Z (刃数)	サイズ 型番	3860A
-0.014	-0.007											
0,4	0,2	0,3	1,2	57	0,35	8	6	23°	20°	2	.0004	●
0,5	0,25	0,4	1,5	57	0,45	8,5	6	22,5°	18,5°	2	.0005	●
0,6	0,3	0,5	1,8	57	0,55	8,5	6	23°	18,5°	2	.0006	●
0,8	0,4	0,5	2,4	57	0,75	9	6	22,5°	17°	2	.0008	●
1	0,5	1	3	57	0,95	9,5	6	22°	15,5°	2	.001	●
1,2	0,6	1	3,6	57	1,15	10	6	21,5°	14°	2	.0012	●
1,5	0,75	1,25	4,5	57	1,4	10,5	6	21,5°	12,5°	2	.0015	●
2	1	1,5	6	57	1,9	11,5	6	21°	10,5°	2	.002	●
3	1,5	2	9	57	2,9	14,5	6	16,5°	6,5°	2	.003	●
4	2	2,5	12	57	3,9	16	6	15,5°	4°	2	.004	●
5	2,5	3	15	57	4,9	18	6	11°	2°	2	.005	●
6	3	3,5	20	57	5,9	-	6	-	-	2	.006	●



超硬ソリッド ボールエンドミル - ショート (2 枚刃)
Solid carbide ball nose end mills – short design (2 flutes)

H

$l_3 = 3 \times d_1$

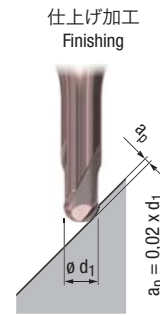
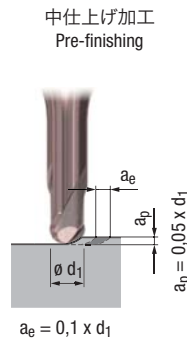
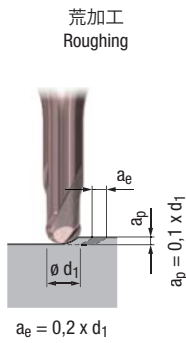

対象製品 · Valid for
3860A

		切削速度 v_c [m/min]	刃あたり送り f_z [mm]	切削速度 v_c [m/min]	刃あたり送り f_z [mm]	切削速度 v_c [m/min]	刃あたり送り f_z [mm]			MMS MQL		
鋼 · Steel materials												
P	1.1	260	$0,013 \times d_1$	320	$0,015 \times d_1$	360	$0,013 \times d_1$	<input type="checkbox"/>	<input checked="" type="checkbox"/>	<input type="checkbox"/>	<input checked="" type="checkbox"/>	
	2.1	240	$0,012 \times d_1$	280	$0,014 \times d_1$	320	$0,012 \times d_1$	<input type="checkbox"/>	<input checked="" type="checkbox"/>	<input type="checkbox"/>	<input checked="" type="checkbox"/>	
	3.1	220	$0,011 \times d_1$	240	$0,013 \times d_1$	280	$0,011 \times d_1$	<input type="checkbox"/>	<input checked="" type="checkbox"/>	<input type="checkbox"/>	<input type="checkbox"/>	
	4.1	200	$0,010 \times d_1$	220	$0,012 \times d_1$	240	$0,010 \times d_1$	<input type="checkbox"/>	<input checked="" type="checkbox"/>	<input type="checkbox"/>	<input type="checkbox"/>	
	5.1	180	$0,009 \times d_1$	200	$0,010 \times d_1$	220	$0,009 \times d_1$	<input type="checkbox"/>	<input checked="" type="checkbox"/>	<input type="checkbox"/>	<input type="checkbox"/>	
ステンレス · Stainless steel materials												
M	1.1							<input type="checkbox"/>	<input type="checkbox"/>	<input type="checkbox"/>	<input type="checkbox"/>	
	2.1							<input type="checkbox"/>	<input type="checkbox"/>	<input type="checkbox"/>	<input type="checkbox"/>	
	3.1							<input type="checkbox"/>	<input type="checkbox"/>	<input type="checkbox"/>	<input type="checkbox"/>	
	4.1							<input type="checkbox"/>	<input type="checkbox"/>	<input type="checkbox"/>	<input type="checkbox"/>	
鋳鉄 · Cast materials												
K	1.1	260	$0,011 \times d_1$	320	$0,013 \times d_1$	360	$0,010 \times d_1$	<input type="checkbox"/>	<input checked="" type="checkbox"/>	<input type="checkbox"/>	<input type="checkbox"/>	
	1.2	260	$0,011 \times d_1$	320	$0,013 \times d_1$	360	$0,010 \times d_1$	<input type="checkbox"/>	<input checked="" type="checkbox"/>	<input type="checkbox"/>	<input type="checkbox"/>	
	2.1	240	$0,011 \times d_1$	280	$0,013 \times d_1$	320	$0,010 \times d_1$	<input type="checkbox"/>	<input checked="" type="checkbox"/>	<input type="checkbox"/>	<input type="checkbox"/>	
	2.2	240	$0,011 \times d_1$	280	$0,013 \times d_1$	320	$0,010 \times d_1$	<input type="checkbox"/>	<input checked="" type="checkbox"/>	<input type="checkbox"/>	<input type="checkbox"/>	
	3.1	220	$0,010 \times d_1$	240	$0,011 \times d_1$	270	$0,008 \times d_1$	<input type="checkbox"/>	<input checked="" type="checkbox"/>	<input type="checkbox"/>	<input type="checkbox"/>	
	3.2	220	$0,010 \times d_1$	240	$0,011 \times d_1$	270	$0,008 \times d_1$	<input type="checkbox"/>	<input checked="" type="checkbox"/>	<input type="checkbox"/>	<input type="checkbox"/>	
	4.1	200	$0,008 \times d_1$	220	$0,009 \times d_1$	240	$0,007 \times d_1$	<input type="checkbox"/>	<input checked="" type="checkbox"/>	<input type="checkbox"/>	<input type="checkbox"/>	
	4.2	180	$0,008 \times d_1$	200	$0,009 \times d_1$	220	$0,007 \times d_1$	<input type="checkbox"/>	<input checked="" type="checkbox"/>	<input type="checkbox"/>	<input type="checkbox"/>	
非鉄 · Non-ferrous materials												
アルミニウム合金 · Aluminium alloys												
N	1.1							<input type="checkbox"/>	<input type="checkbox"/>	<input type="checkbox"/>	<input type="checkbox"/>	
	1.2							<input type="checkbox"/>	<input type="checkbox"/>	<input type="checkbox"/>	<input type="checkbox"/>	
	1.3							<input type="checkbox"/>	<input type="checkbox"/>	<input type="checkbox"/>	<input type="checkbox"/>	
	1.4							<input type="checkbox"/>	<input type="checkbox"/>	<input type="checkbox"/>	<input type="checkbox"/>	
	1.5							<input type="checkbox"/>	<input type="checkbox"/>	<input type="checkbox"/>	<input type="checkbox"/>	
	1.6							<input type="checkbox"/>	<input type="checkbox"/>	<input type="checkbox"/>	<input type="checkbox"/>	
	銅合金 · Copper alloys											
	2.1								<input type="checkbox"/>	<input type="checkbox"/>	<input type="checkbox"/>	<input type="checkbox"/>
	2.2								<input type="checkbox"/>	<input type="checkbox"/>	<input type="checkbox"/>	<input type="checkbox"/>
	2.3								<input type="checkbox"/>	<input type="checkbox"/>	<input type="checkbox"/>	<input type="checkbox"/>
	2.4								<input type="checkbox"/>	<input type="checkbox"/>	<input type="checkbox"/>	<input type="checkbox"/>
	2.5								<input type="checkbox"/>	<input type="checkbox"/>	<input type="checkbox"/>	<input type="checkbox"/>
	2.6								<input type="checkbox"/>	<input type="checkbox"/>	<input type="checkbox"/>	<input type="checkbox"/>
	2.7								<input type="checkbox"/>	<input type="checkbox"/>	<input type="checkbox"/>	<input type="checkbox"/>
	2.8								<input type="checkbox"/>	<input type="checkbox"/>	<input type="checkbox"/>	<input type="checkbox"/>
	マグネシウム合金 · Magnesium alloys											
3.1								<input type="checkbox"/>	<input type="checkbox"/>	<input type="checkbox"/>	<input type="checkbox"/>	
3.2								<input type="checkbox"/>	<input type="checkbox"/>	<input type="checkbox"/>	<input type="checkbox"/>	
合成樹脂 · Synthetics												
4.1								<input type="checkbox"/>	<input type="checkbox"/>	<input type="checkbox"/>	<input type="checkbox"/>	
4.2								<input type="checkbox"/>	<input type="checkbox"/>	<input type="checkbox"/>	<input type="checkbox"/>	
4.3								<input type="checkbox"/>	<input type="checkbox"/>	<input type="checkbox"/>	<input type="checkbox"/>	
4.4								<input type="checkbox"/>	<input type="checkbox"/>	<input type="checkbox"/>	<input type="checkbox"/>	
特殊合金 · Special materials												
5.1								<input type="checkbox"/>	<input type="checkbox"/>	<input type="checkbox"/>	<input type="checkbox"/>	
5.2								<input type="checkbox"/>	<input type="checkbox"/>	<input type="checkbox"/>	<input type="checkbox"/>	
5.3								<input type="checkbox"/>	<input type="checkbox"/>	<input type="checkbox"/>	<input type="checkbox"/>	
耐熱合金 · Special materials												
チタン合金 · Titanium alloys												
S	1.1							<input type="checkbox"/>	<input type="checkbox"/>	<input type="checkbox"/>	<input type="checkbox"/>	
	1.2							<input type="checkbox"/>	<input type="checkbox"/>	<input type="checkbox"/>	<input type="checkbox"/>	
	1.3							<input type="checkbox"/>	<input type="checkbox"/>	<input type="checkbox"/>	<input type="checkbox"/>	
	ニッケル基、コバルト基、鉄基合金 · Nickel alloys, cobalt alloys and iron alloys											
	2.1								<input type="checkbox"/>	<input type="checkbox"/>	<input type="checkbox"/>	<input type="checkbox"/>
	2.2								<input type="checkbox"/>	<input type="checkbox"/>	<input type="checkbox"/>	<input type="checkbox"/>
	2.3								<input type="checkbox"/>	<input type="checkbox"/>	<input type="checkbox"/>	<input type="checkbox"/>
2.4								<input type="checkbox"/>	<input type="checkbox"/>	<input type="checkbox"/>	<input type="checkbox"/>	
2.5								<input type="checkbox"/>	<input type="checkbox"/>	<input type="checkbox"/>	<input type="checkbox"/>	
2.6								<input type="checkbox"/>	<input type="checkbox"/>	<input type="checkbox"/>	<input type="checkbox"/>	
高硬度鋼 · Hard materials												
H	1.1	160	$0,008 \times d_1$	200	$0,009 \times d_1$	220	$0,009 \times d_1$	<input type="checkbox"/>	<input checked="" type="checkbox"/>	<input type="checkbox"/>	<input type="checkbox"/>	
	1.2	120	$0,007 \times d_1$	180	$0,008 \times d_1$	200	$0,008 \times d_1$	<input type="checkbox"/>	<input checked="" type="checkbox"/>	<input type="checkbox"/>	<input type="checkbox"/>	
	1.3			160	$0,008 \times d_1$	180	$0,008 \times d_1$	<input type="checkbox"/>	<input checked="" type="checkbox"/>	<input type="checkbox"/>	<input type="checkbox"/>	
	1.4			140	$0,007 \times d_1$	160	$0,007 \times d_1$	<input type="checkbox"/>	<input checked="" type="checkbox"/>	<input type="checkbox"/>	<input type="checkbox"/>	
	1.5			120	$0,006 \times d_1$	140	$0,006 \times d_1$	<input type="checkbox"/>	<input checked="" type="checkbox"/>	<input type="checkbox"/>	<input type="checkbox"/>	

v_c = 切削速度 · Cutting speed
 f_z = 刃あたり送り · Feed per tooth

■ = 最適 · very suitable
□ = 適用可能 · suitable

- ハイパフォーマンスツール
- 最大16 x d₁ までの 6種類のネック長さ
- より厳しいR公差
- h4 公差の高精度シャンク

- High performance tool
- 6 cylindrical neck lengths up to 16 x d₁ available
- High-precision radius
- Highly precise straight shank with tolerance h4

H

超硬

DIN 6535
HA
HB

30°

ボール

1-3°

≤ 66 HRC



new



高硬度鋼

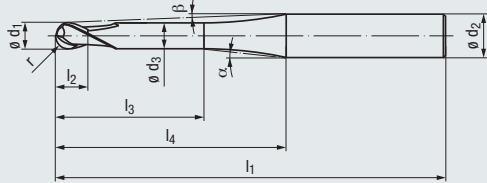
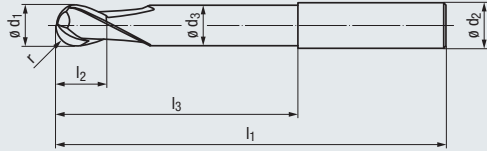

コーティング · Coating

アプリケーション - 被削材 (P4参照)

- 高硬度鋼加工用に新しく開発された特別な TIALN-コーティングを採用
- 立壁のあるキャビティの加工に
- HSC-高速仕上げ加工に最適

Applications – material (see page 4)

- Special TiAlN-coating for machining hardened materials
- For milling of cylindrical cavities
- Suitable for HSC finishing

TIALN

P	3.1-5.1	1.1-2.1
K	1.1-4.2	
H	1.1-1.5	

l₃ = 5 x d₁ - ロング · Long design

製品型番 · Order code

∅ d ₁	r	l ₂	l ₃	l ₁	∅ d ₃	l ₄	∅ d ₂ h4	α	β	Z (刃数)	サイズ 型番	3861A
-0.014	-0.007											
0,4	0,2	0,3	2	57	0,35	8,5	6	24°	19°	2	.0004	●
0,5	0,25	0,4	2,5	57	0,45	9,5	6	22,5°	17°	2	.0005	●
0,6	0,3	0,5	3	57	0,55	9,5	6	23,5°	16,5°	2	.0006	●
0,8	0,4	0,5	4	57	0,75	10,5	6	22,5°	14,5°	2	.0008	●
1	0,5	1	5	57	0,95	11,5	6	22°	13°	2	.001	●
1,2	0,6	1	6	57	1,15	12	6	22,5°	12°	2	.0012	●
1,5	0,75	1,25	7,5	57	1,4	13,5	6	21,5°	10°	2	.0015	●
2	1	1,5	10	57	1,9	14	6	28°	9°	2	.002	●
3	1,5	2	15	57	2,9	20,5	6	16°	5°	2	.003	●
4	2	2,5	20	63	3,9	24	6	15,5°	3°	2	.004	●
5	2,5	3	25	72	4,9	35	6	4°	1,5°	2	.005	●
6	3	3,5	30	72	5,9	-	6	-	-	2	.006	●

超硬ソリッド ボールエンドミル - ロング (2 枚刃)
Solid carbide ball nose end mills - long design (2 flutes)

対象製品 · Valid for
3861A



H

$l_3 = 5 \times d_1$

荒加工
Roughing

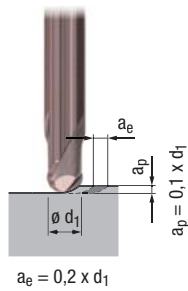

中仕上げ加工
Pre-finishing

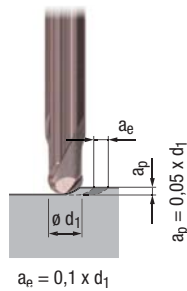

仕上げ加工
Finishing

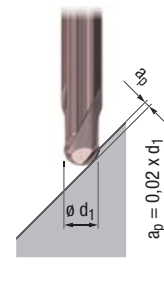

	切削速度 v_c [m/min]	刃あたり送り f_z [mm]	切削速度 v_c [m/min]	刃あたり送り f_z [mm]	切削速度 v_c [m/min]	刃あたり送り f_z [mm]			MMS MQL	
--	-----------------------	----------------------	-----------------------	----------------------	-----------------------	----------------------	--	--	------------	--

鋼 · Steel materials

P	1.1	240	$0,013 \times d_1$	300	$0,015 \times d_1$	340	$0,013 \times d_1$	<input type="checkbox"/>	<input checked="" type="checkbox"/>	<input type="checkbox"/>	<input checked="" type="checkbox"/>
	2.1	220	$0,012 \times d_1$	260	0,014	340	$0,012 \times d_1$	<input type="checkbox"/>	<input checked="" type="checkbox"/>	<input type="checkbox"/>	<input checked="" type="checkbox"/>
	3.1	200	$0,011 \times d_1$	220	$0,013 \times d_1$	260	$0,011 \times d_1$	<input type="checkbox"/>	<input checked="" type="checkbox"/>	<input type="checkbox"/>	
	4.1	180	$0,010 \times d_1$	200	$0,012 \times d_1$	220	$0,010 \times d_1$	<input type="checkbox"/>	<input checked="" type="checkbox"/>	<input type="checkbox"/>	
	5.1	160	$0,009 \times d_1$	180	$0,010 \times d_1$	200	$0,009 \times d_1$	<input type="checkbox"/>	<input checked="" type="checkbox"/>	<input type="checkbox"/>	

ステンレス · Stainless steel materials

M	1.1							<input type="checkbox"/>	<input checked="" type="checkbox"/>	<input type="checkbox"/>	<input checked="" type="checkbox"/>
	2.1							<input type="checkbox"/>	<input checked="" type="checkbox"/>	<input type="checkbox"/>	<input checked="" type="checkbox"/>
	3.1							<input type="checkbox"/>	<input checked="" type="checkbox"/>	<input type="checkbox"/>	<input checked="" type="checkbox"/>
	4.1							<input type="checkbox"/>	<input checked="" type="checkbox"/>	<input type="checkbox"/>	<input checked="" type="checkbox"/>

鋳鉄 · Cast materials

K	1.1	240	$0,011 \times d_1$	300	$0,013 \times d_1$	340	$0,010 \times d_1$	<input type="checkbox"/>	<input checked="" type="checkbox"/>	<input type="checkbox"/>	<input type="checkbox"/>
	1.2	240	$0,011 \times d_1$	300	$0,013 \times d_1$	340	$0,010 \times d_1$	<input type="checkbox"/>	<input checked="" type="checkbox"/>	<input type="checkbox"/>	<input type="checkbox"/>
	2.1	220	$0,011 \times d_1$	260	$0,013 \times d_1$	300	$0,010 \times d_1$	<input type="checkbox"/>	<input checked="" type="checkbox"/>	<input type="checkbox"/>	<input type="checkbox"/>
	2.2	220	$0,011 \times d_1$	260	$0,013 \times d_1$	300	$0,010 \times d_1$	<input type="checkbox"/>	<input checked="" type="checkbox"/>	<input type="checkbox"/>	<input type="checkbox"/>
	3.1	200	$0,010 \times d_1$	220	$0,011 \times d_1$	250	$0,008 \times d_1$	<input type="checkbox"/>	<input checked="" type="checkbox"/>	<input type="checkbox"/>	
	3.2	200	$0,010 \times d_1$	220	$0,011 \times d_1$	250	$0,008 \times d_1$	<input type="checkbox"/>	<input checked="" type="checkbox"/>	<input type="checkbox"/>	
	4.1	180	$0,008 \times d_1$	200	$0,009 \times d_1$	220	$0,007 \times d_1$	<input type="checkbox"/>	<input checked="" type="checkbox"/>	<input type="checkbox"/>	
	4.2	160	$0,008 \times d_1$	180	$0,009 \times d_1$	200	$0,007 \times d_1$	<input type="checkbox"/>	<input checked="" type="checkbox"/>	<input type="checkbox"/>	

非鉄 · Non-ferrous materials

アルミニウム合金 · Aluminium alloys

N	1.1							<input type="checkbox"/>	<input checked="" type="checkbox"/>	<input type="checkbox"/>	<input type="checkbox"/>
	1.2							<input type="checkbox"/>	<input checked="" type="checkbox"/>	<input type="checkbox"/>	<input type="checkbox"/>
	1.3							<input type="checkbox"/>	<input checked="" type="checkbox"/>	<input type="checkbox"/>	<input type="checkbox"/>
	1.4							<input type="checkbox"/>	<input checked="" type="checkbox"/>	<input type="checkbox"/>	<input type="checkbox"/>
	1.5							<input type="checkbox"/>	<input checked="" type="checkbox"/>	<input type="checkbox"/>	<input type="checkbox"/>
	1.6							<input type="checkbox"/>	<input checked="" type="checkbox"/>	<input type="checkbox"/>	<input type="checkbox"/>

銅合金 · Copper alloys

N	2.1							<input type="checkbox"/>	<input checked="" type="checkbox"/>	<input type="checkbox"/>	<input type="checkbox"/>
	2.2							<input type="checkbox"/>	<input checked="" type="checkbox"/>	<input type="checkbox"/>	<input type="checkbox"/>
	2.3							<input type="checkbox"/>	<input checked="" type="checkbox"/>	<input type="checkbox"/>	<input type="checkbox"/>
	2.4							<input type="checkbox"/>	<input checked="" type="checkbox"/>	<input type="checkbox"/>	<input type="checkbox"/>
	2.5							<input type="checkbox"/>	<input checked="" type="checkbox"/>	<input type="checkbox"/>	<input type="checkbox"/>
	2.6							<input type="checkbox"/>	<input checked="" type="checkbox"/>	<input type="checkbox"/>	<input type="checkbox"/>
	2.7							<input type="checkbox"/>	<input checked="" type="checkbox"/>	<input type="checkbox"/>	<input type="checkbox"/>
	2.8							<input type="checkbox"/>	<input checked="" type="checkbox"/>	<input type="checkbox"/>	<input type="checkbox"/>

マグネシウム合金 · Magnesium alloys

N	3.1							<input type="checkbox"/>	<input checked="" type="checkbox"/>	<input type="checkbox"/>	<input type="checkbox"/>
	3.2							<input type="checkbox"/>	<input checked="" type="checkbox"/>	<input type="checkbox"/>	<input type="checkbox"/>

合成樹脂 · Synthetics

N	4.1							<input type="checkbox"/>	<input checked="" type="checkbox"/>	<input type="checkbox"/>	<input type="checkbox"/>
	4.2							<input type="checkbox"/>	<input checked="" type="checkbox"/>	<input type="checkbox"/>	<input type="checkbox"/>
	4.3							<input type="checkbox"/>	<input checked="" type="checkbox"/>	<input type="checkbox"/>	<input type="checkbox"/>
	4.4							<input type="checkbox"/>	<input checked="" type="checkbox"/>	<input type="checkbox"/>	<input type="checkbox"/>

特殊合金 · Special materials

N	5.1							<input type="checkbox"/>	<input checked="" type="checkbox"/>	<input type="checkbox"/>	<input type="checkbox"/>
	5.2							<input type="checkbox"/>	<input checked="" type="checkbox"/>	<input type="checkbox"/>	<input type="checkbox"/>
	5.3							<input type="checkbox"/>	<input checked="" type="checkbox"/>	<input type="checkbox"/>	<input type="checkbox"/>

耐熱合金 · Special materials

チタン合金 · Titanium alloys

S	1.1							<input type="checkbox"/>	<input checked="" type="checkbox"/>	<input type="checkbox"/>	<input type="checkbox"/>
	1.2							<input type="checkbox"/>	<input checked="" type="checkbox"/>	<input type="checkbox"/>	<input type="checkbox"/>
	1.3							<input type="checkbox"/>	<input checked="" type="checkbox"/>	<input type="checkbox"/>	<input type="checkbox"/>

ニッケル基、コバルト基、鉄基合金 · Nickel alloys, cobalt alloys and iron alloys

S	2.1							<input type="checkbox"/>	<input checked="" type="checkbox"/>	<input type="checkbox"/>	<input type="checkbox"/>
	2.2							<input type="checkbox"/>	<input checked="" type="checkbox"/>	<input type="checkbox"/>	<input type="checkbox"/>
	2.3							<input type="checkbox"/>	<input checked="" type="checkbox"/>	<input type="checkbox"/>	<input type="checkbox"/>
	2.4							<input type="checkbox"/>	<input checked="" type="checkbox"/>	<input type="checkbox"/>	<input type="checkbox"/>
	2.5							<input type="checkbox"/>	<input checked="" type="checkbox"/>	<input type="checkbox"/>	<input type="checkbox"/>
	2.6							<input type="checkbox"/>	<input checked="" type="checkbox"/>	<input type="checkbox"/>	<input type="checkbox"/>

高硬度鋼 · Hard materials

H	1.1	140	$0,008 \times d_1$	180	$0,009 \times d_1$	200	$0,009 \times d_1$	<input type="checkbox"/>	<input checked="" type="checkbox"/>	<input type="checkbox"/>	<input type="checkbox"/>
	1.2	110	$0,007 \times d_1$	160	$0,008 \times d_1$	180	$0,008 \times d_1$	<input type="checkbox"/>	<input checked="" type="checkbox"/>	<input type="checkbox"/>	<input type="checkbox"/>
	1.3			140	$0,008 \times d_1$	160	$0,008 \times d_1$	<input type="checkbox"/>	<input checked="" type="checkbox"/>	<input type="checkbox"/>	<input type="checkbox"/>
	1.4			130	$0,007 \times d_1$	140	$0,007 \times d_1$	<input type="checkbox"/>	<input checked="" type="checkbox"/>	<input type="checkbox"/>	<input type="checkbox"/>
	1.5			110	$0,006 \times d_1$	130	$0,006 \times d_1$	<input type="checkbox"/>	<input checked="" type="checkbox"/>	<input type="checkbox"/>	<input type="checkbox"/>

v_c = 切削速度 · Cutting speed
 f_z = 刃あたり送り · Feed per tooth

■ = 最適 · very suitable
□ = 適用可能 · suitable

- ハイパフォーマンスツール
- 最大16 x d₁ までの 6種類のネック長さ
- より厳しいR公差
- h4 公差の高精度シャンク

- High performance tool
- 6 cylindrical neck lengths up to 16 x d₁ available
- High-precision radius
- Highly precise straight shank with tolerance h4

H

超硬

DIN 6535
HA
HB

30° **ボール**

1-3°

≤ 66 HRC

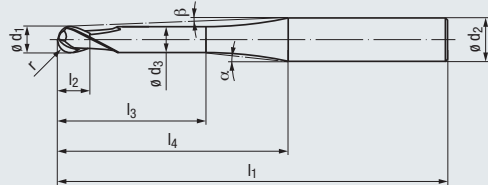
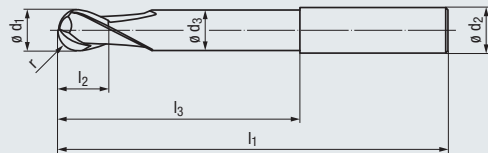

new

new



高硬度鋼

高硬度鋼

コーティング · Coating

アプリケーション - 被削材 (P4参照)

Applications - material (see page 4)

- 高硬度鋼加工用に新しく開発された特別な TiAlN-コーティングを採用
- 立壁のあるキャビティの加工に
- HSC-高速仕上げ加工に最適

- Special TiAlN-coating for machining hardened materials
- For milling of cylindrical cavities
- Suitable for HSC finishing

TiAlN

TiAlN

P	3.1-5.1	1.1-2.1
K	1.1-4.2	
H	1.1-1.5	

P	3.1-5.1	1.1-2.1
K	1.1-4.2	
H	1.1-1.5	

l₃ = 8 x d₁ - エクストラロング · Extra long design

製品型番 · Order code

∅ d ₁	r	l ₂	l ₃	l ₁	∅ d ₃	l ₄	∅ d ₂ h4	α	β	Z (刃数)	サイズ 型番	3862A
-0.014	-0.007											
0.4	0.2	0.3	3.2	57	0.35	9.5	6	25°	17°	2	.0004	●
0.5	0.25	0.4	4	57	0.45	11	6	22.5°	14.5°	2	.0005	●
0.6	0.3	0.5	4.8	57	0.55	11	6	24.5°	14.5°	2	.0006	●
0.8	0.4	0.5	6.4	57	0.75	13	6	22.5°	12°	2	.0008	●
1	0.5	1	8	57	0.95	14.5	6	22°	10.5°	2	.001	●
1.2	0.6	1	9.6	57	1.15	16	6	21.5°	9°	2	.0012	●
1.5	0.75	1.25	12	57	1.4	18	6	21.5°	8°	2	.0015	●
2	1	1.5	16	57	1.9	20	6	28°	6.5°	2	.002	●
3	1.5	2	24	68	2.9	30	6	15°	3.5°	2	.003	●
4	2	2.5	32	80	3.9	42	6	6.5°	2°	2	.004	●
5	2.5	3	40	80	4.9	43	6	11°	1.5°	2	.005	●
6	3	3.5	48	86	5.9	-	6	-	-	2	.006	●

l₃ = 10 x d₁ - エクストラロング · Extra long design

製品型番 · Order code

∅ d ₁	r	l ₂	l ₃	l ₁	∅ d ₃	l ₄	∅ d ₂ h4	α	β	Z (刃数)	サイズ 型番	3863A
-0.014	-0.007											
0.4	0.2	0.3	4	57	0.35	10.5	6	24°	15.5°	2	.0004	●
0.5	0.25	0.4	5	57	0.45	12	6	22.5°	13.5°	2	.0005	●
0.6	0.3	0.5	6	57	0.55	12.5	6	23.5°	13°	2	.0006	●
0.8	0.4	0.5	8	57	0.75	14.5	6	22.5°	11°	2	.0008	●
1	0.5	1	10	57	0.95	16.5	6	22°	9.5°	2	.001	●
1.2	0.6	1	12	57	1.15	18.5	6	21°	8°	2	.0012	●
1.5	0.75	1.25	15	57	1.4	20	6	25.5°	7°	2	.0015	●
2	1	1.5	20	63	1.9	24	6	28°	5.5°	2	.002	●
3	1.5	2	30	72	2.9	35	6	18°	3°	2	.003	●
4	2	2.5	40	80	3.9	44	6	15.5°	2°	2	.004	●
5	2.5	3	50	100	4.9	53	6	11°	1°	2	.005	●
6	3	3.5	60	100	5.9	-	6	-	-	2	.006	●

超硬ソリッド ボールエンドミル - エクストラロング (2 枚刃)
Solid carbide ball nose end mills - extra long design (2 flutes)

対象製品 · Valid for
3862A
3863A

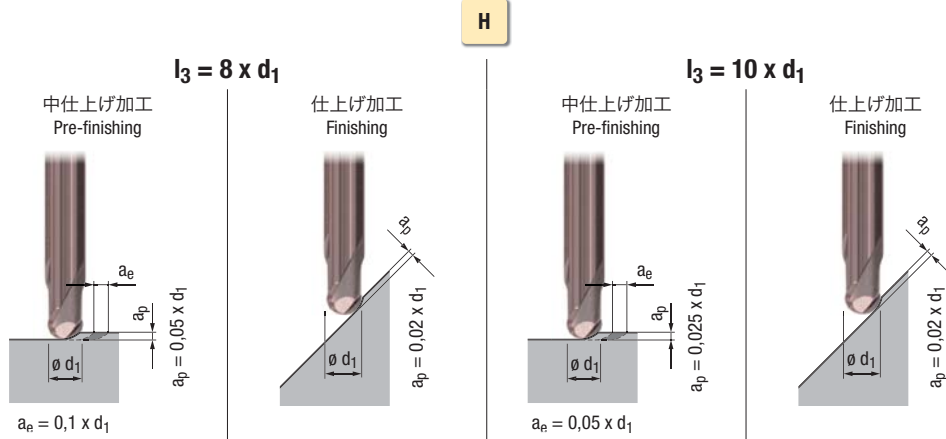

H

	切削速度 v _c [m/min]	刃あたり送り f _z [mm]	切削速度 v _c [m/min]	刃あたり送り f _z [mm]	切削速度 v _c [m/min]	刃あたり送り f _z [mm]	切削速度 v _c [m/min]	刃あたり送り f _z [mm]			MMS MQL		
鋼 · Steel materials													
P	1.1	240	0,013 x d ₁	280	0,013 x d ₁	240	0,013 x d ₁	280	0,013 x d ₁	<input type="checkbox"/>	<input checked="" type="checkbox"/>	<input type="checkbox"/>	<input checked="" type="checkbox"/>
	2.1	220	0,012 x d ₁	260	0,012 x d ₁	220	0,012 x d ₁	260	0,012 x d ₁	<input type="checkbox"/>	<input checked="" type="checkbox"/>	<input type="checkbox"/>	<input checked="" type="checkbox"/>
	3.1	200	0,011 x d ₁	240	0,011 x d ₁	200	0,011 x d ₁	240	0,011 x d ₁	<input type="checkbox"/>	<input checked="" type="checkbox"/>	<input type="checkbox"/>	<input checked="" type="checkbox"/>
	4.1	180	0,010 x d ₁	210	0,010 x d ₁	180	0,010 x d ₁	210	0,010 x d ₁	<input type="checkbox"/>	<input checked="" type="checkbox"/>	<input type="checkbox"/>	<input checked="" type="checkbox"/>
	5.1	160	0,009 x d ₁	190	0,009 x d ₁	160	0,009 x d ₁	190	0,009 x d ₁	<input type="checkbox"/>	<input checked="" type="checkbox"/>	<input type="checkbox"/>	<input checked="" type="checkbox"/>
ステンレス · Stainless steel materials													
M	1.1												
	2.1												
	3.1												
	4.1												
鋳鉄 · Cast materials													
K	1.1	240	0,011 x d ₁	280	0,010 x d ₁	240	0,011 x d ₁	280	0,010 x d ₁	<input type="checkbox"/>	<input checked="" type="checkbox"/>	<input type="checkbox"/>	<input type="checkbox"/>
	1.2	240	0,011 x d ₁	280	0,010 x d ₁	240	0,011 x d ₁	280	0,010 x d ₁	<input type="checkbox"/>	<input checked="" type="checkbox"/>	<input type="checkbox"/>	<input type="checkbox"/>
	2.1	220	0,011 x d ₁	260	0,010 x d ₁	220	0,011 x d ₁	260	0,010 x d ₁	<input type="checkbox"/>	<input checked="" type="checkbox"/>	<input type="checkbox"/>	<input type="checkbox"/>
	2.2	220	0,011 x d ₁	260	0,010 x d ₁	220	0,011 x d ₁	260	0,010 x d ₁	<input type="checkbox"/>	<input checked="" type="checkbox"/>	<input type="checkbox"/>	<input type="checkbox"/>
	3.1	200	0,010 x d ₁	240	0,008 x d ₁	200	0,010 x d ₁	240	0,008 x d ₁	<input type="checkbox"/>	<input checked="" type="checkbox"/>	<input type="checkbox"/>	<input type="checkbox"/>
	3.2	200	0,010 x d ₁	240	0,008 x d ₁	200	0,010 x d ₁	240	0,008 x d ₁	<input type="checkbox"/>	<input checked="" type="checkbox"/>	<input type="checkbox"/>	<input type="checkbox"/>
	4.1	180	0,008 x d ₁	210	0,007 x d ₁	180	0,008 x d ₁	210	0,007 x d ₁	<input type="checkbox"/>	<input checked="" type="checkbox"/>	<input type="checkbox"/>	<input type="checkbox"/>
4.2	160	0,008 x d ₁	190	0,007 x d ₁	160	0,008 x d ₁	190	0,007 x d ₁	<input type="checkbox"/>	<input checked="" type="checkbox"/>	<input type="checkbox"/>	<input type="checkbox"/>	
非鉄 · Non-ferrous materials													
アルミニウム合金 · Aluminium alloys													
N	1.1												
	1.2												
	1.3												
	1.4												
	1.5												
	1.6												
	銅合金 · Copper alloys												
	2.1												
	2.2												
	2.3												
	2.4												
	2.5												
	2.6												
	2.7												
	2.8												
	マグネシウム合金 · Magnesium alloys												
3.1													
3.2													
合成樹脂 · Synthetics													
4.1													
4.2													
4.3													
4.4													
特殊合金 · Special materials													
5.1													
5.2													
5.3													
耐熱合金 · Special materials													
チタン合金 · Titanium alloys													
1.1													
1.2													
1.3													
S	ニッケル基、コバルト基、鉄基合金 · Nickel alloys, cobalt alloys and iron alloys												
	2.1												
	2.2												
	2.3												
	2.4												
	2.5												
2.6													
高硬度鋼 · Hard materials													
H	1.1	140	0,008 x d ₁	180	0,009 x d ₁	140	0,008 x d ₁	180	0,009 x d ₁	<input type="checkbox"/>	<input checked="" type="checkbox"/>	<input type="checkbox"/>	<input type="checkbox"/>
	1.2	120	0,007 x d ₁	160	0,008 x d ₁	120	0,007 x d ₁	160	0,008 x d ₁	<input type="checkbox"/>	<input checked="" type="checkbox"/>	<input type="checkbox"/>	<input type="checkbox"/>
	1.3	110	0,008 x d ₁	140	0,008 x d ₁	110	0,008 x d ₁	140	0,008 x d ₁	<input type="checkbox"/>	<input checked="" type="checkbox"/>	<input type="checkbox"/>	<input type="checkbox"/>
	1.4	100	0,007 x d ₁	120	0,007 x d ₁	100	0,007 x d ₁	120	0,007 x d ₁	<input type="checkbox"/>	<input checked="" type="checkbox"/>	<input type="checkbox"/>	<input type="checkbox"/>
	1.5	80	0,006 x d ₁	100	0,006 x d ₁	80	0,006 x d ₁	100	0,006 x d ₁	<input type="checkbox"/>	<input checked="" type="checkbox"/>	<input type="checkbox"/>	<input type="checkbox"/>

v_c = 切削速度 · Cutting speed
f_z = 刃あたり送り · Feed per tooth

■ = 最適 · very suitable
□ = 適用可能 · suitable

- ハイパフォーマンスツール
- 最大16 x d₁ までの 6種類のネック長さ
- より厳しいR公差
- h4 公差の高精度シャンク

- High performance tool
- 6 cylindrical neck lengths up to 16 x d₁ available
- High-precision radius
- Highly precise straight shank with tolerance h4

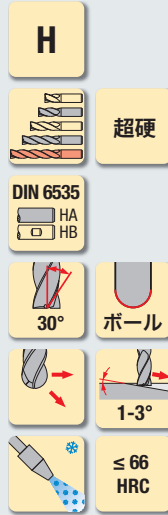

new



高硬度鋼

new



高硬度鋼

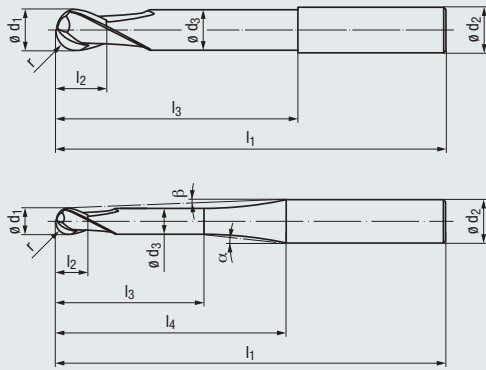

コーティング · Coating

アプリケーション - 被削材 (P4参照)

- 高硬度鋼加工用に新しく開発された特別な TiAlN-コーティングを採用
- 立壁のあるキャビティの加工に
- HSC-高速仕上げ加工に最適

Applications - material (see page 4)

- Special TiAlN-coating for machining hardened materials
- For milling of cylindrical cavities
- Suitable for HSC finishing

TiAlN

TiAlN

P	3.1-5.1	1.1-2.1	P	3.1-5.1	1.1-2.1
K	1.1-4.2		K	1.1-4.2	
H	1.1-1.5		H	1.1-1.5	

l₃ = 12 x d₁ - エクストラロング · Extra long design

製品型番 · Order code

∅ d ₁	r	l ₂	l ₃	l ₁	∅ d ₃	l ₄	∅ d ₂ h4	α	β	Z (刃数)	サイズ 型番	3864A
-0.014	-0.007											
0.4	0.2	0.3	4.8	57	0.35	11.5	6	23.5°	14.5°	2	.0004	●
0.5	0.25	0.4	6	57	0.45	13	6	22.5°	12.5°	2	.0005	●
0.6	0.3	0.5	7.2	57	0.55	13.5	6	24°	12°	2	.0006	●
0.8	0.4	0.5	9.6	57	0.75	16	6	23°	10°	2	.0008	●
1	0.5	1	12	57	0.95	18.5	6	22°	8.5°	2	.001	●
1.2	0.6	1	14.4	57	1.15	21	6	21°	7°	2	.0012	●
1.5	0.75	1.25	18	63	1.4	24	6	21.5°	6°	2	.0015	●
2	1	1.5	24	66	1.9	28	6	28°	4.5°	2	.002	●
3	1.5	2	36	80	2.9	42.5	6	14°	2.5°	2	.003	●
4	2	2.5	48	100	3.9	61	6	5.5°	1.5°	2	.004	●
5	2.5	3	60	100	4.9	63	6	11°	1°	2	.005	●
6	3	3.5	72	110	5.9	-	6	-	-	2	.006	●

l₃ = 16 x d₁ - エクストラロング · Extra long design

製品型番 · Order code

∅ d ₁	r	l ₂	l ₃	l ₁	∅ d ₃	l ₄	∅ d ₂ h4	α	β	Z (刃数)	サイズ 型番	3865A
-0.014	-0.007											
1	0.5	1	16	57	0.95	20.5	6	30°	7.5°	2	.001	●
2	1	1.5	32	80	1.9	37.5	6	21°	3.1°	2	.002	●



超硬ソリッド ボールエンドミル - エクストラロング (2 枚刃)
Solid carbide ball nose end mills - extra long design (2 flutes)

H

$$l_3 = 12 \times d_1 \cdot l_3 = 16 \times d_1$$

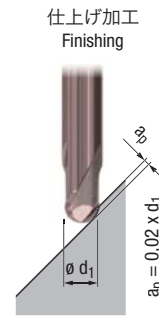
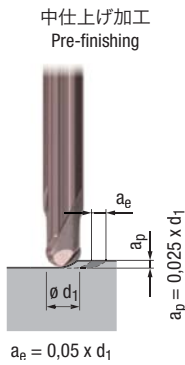

対象製品 · Valid for
3864A
3865A



	切削速度 v_c [m/min]	刃あたり送り f_z [mm]	切削速度 v_c [m/min]	刃あたり送り f_z [mm]	<input type="checkbox"/>	<input checked="" type="checkbox"/>	<input type="checkbox"/>	<input checked="" type="checkbox"/>	
鋼 · Steel materials									
P	1.1	240	$0,013 \times d_1$	280	$0,013 \times d_1$	<input type="checkbox"/>	<input checked="" type="checkbox"/>	<input type="checkbox"/>	
	2.1	220	$0,012 \times d_1$	260	$0,012 \times d_1$	<input type="checkbox"/>	<input checked="" type="checkbox"/>	<input type="checkbox"/>	
	3.1	200	$0,011 \times d_1$	240	$0,011 \times d_1$	<input type="checkbox"/>	<input checked="" type="checkbox"/>	<input type="checkbox"/>	
	4.1	180	$0,010 \times d_1$	210	$0,010 \times d_1$	<input type="checkbox"/>	<input checked="" type="checkbox"/>	<input type="checkbox"/>	
	5.1	160	$0,009 \times d_1$	190	$0,009 \times d_1$	<input type="checkbox"/>	<input checked="" type="checkbox"/>	<input type="checkbox"/>	
ステンレス · Stainless steel materials									
M	1.1								
	2.1								
	3.1								
	4.1								
鋳鉄 · Cast materials									
K	1.1	240	$0,011 \times d_1$	280	$0,010 \times d_1$	<input type="checkbox"/>	<input checked="" type="checkbox"/>	<input type="checkbox"/>	
	1.2	240	$0,011 \times d_1$	280	$0,010 \times d_1$	<input type="checkbox"/>	<input checked="" type="checkbox"/>	<input type="checkbox"/>	
	2.1	220	$0,011 \times d_1$	260	$0,010 \times d_1$	<input type="checkbox"/>	<input checked="" type="checkbox"/>	<input type="checkbox"/>	
	2.2	220	$0,011 \times d_1$	260	$0,010 \times d_1$	<input type="checkbox"/>	<input checked="" type="checkbox"/>	<input type="checkbox"/>	
	3.1	200	$0,010 \times d_1$	240	$0,008 \times d_1$	<input type="checkbox"/>	<input checked="" type="checkbox"/>	<input type="checkbox"/>	
	3.2	200	$0,010 \times d_1$	240	$0,008 \times d_1$	<input type="checkbox"/>	<input checked="" type="checkbox"/>	<input type="checkbox"/>	
	4.1	180	$0,008 \times d_1$	210	$0,007 \times d_1$	<input type="checkbox"/>	<input checked="" type="checkbox"/>	<input type="checkbox"/>	
	4.2	160	$0,008 \times d_1$	190	$0,007 \times d_1$	<input type="checkbox"/>	<input checked="" type="checkbox"/>	<input type="checkbox"/>	
非鉄 · Non-ferrous materials									
アルミニウム合金 · Aluminium alloys									
N	1.1								
	1.2								
	1.3								
	1.4								
	1.5								
	1.6								
	銅合金 · Copper alloys								
	2.1								
	2.2								
	2.3								
	2.4								
	2.5								
	2.6								
	2.7								
	2.8								
	マグネシウム合金 · Magnesium alloys								
3.1									
3.2									
合成樹脂 · Synthetics									
4.1									
4.2									
4.3									
4.4									
特殊合金 · Special materials									
5.1									
5.2									
5.3									
耐熱合金 · Special materials									
チタン合金 · Titanium alloys									
S	1.1								
	1.2								
	1.3								
	ニッケル基、コバルト基、鉄基合金 · Nickel alloys, cobalt alloys and iron alloys								
	2.1								
	2.2								
	2.3								
2.4									
2.5									
2.6									
高硬度鋼 · Hard materials									
H	1.1	140	$0,008 \times d_1$	180	$0,009 \times d_1$	<input type="checkbox"/>	<input checked="" type="checkbox"/>	<input type="checkbox"/>	
	1.2	120	$0,007 \times d_1$	160	$0,008 \times d_1$	<input type="checkbox"/>	<input checked="" type="checkbox"/>	<input type="checkbox"/>	
	1.3	110	$0,008 \times d_1$	140	$0,008 \times d_1$	<input type="checkbox"/>	<input checked="" type="checkbox"/>	<input type="checkbox"/>	
	1.4	100	$0,007 \times d_1$	120	$0,007 \times d_1$	<input type="checkbox"/>	<input checked="" type="checkbox"/>	<input type="checkbox"/>	
	1.5	80	$0,006 \times d_1$	100	$0,006 \times d_1$	<input type="checkbox"/>	<input checked="" type="checkbox"/>	<input type="checkbox"/>	

v_c = 切削速度 · Cutting speed
 f_z = 刃あたり送り · Feed per tooth

■ = 最適 · very suitable
□ = 適用可能 · suitable

- ハイパフォーマンスツール
- 最適化されたチゼルエッジ設計
- より厳しいR公差
- 4種類の工具長さ
- h4公差の高精度シャンク

- High performance tool
- Optimised chisel edge
- High-precision radius
- 4 lengths available
- Highly precise straight shank with tolerance h4

H

超硬

DIN 6535
HA
HB

30° **ボール**

1-3°

≤ 66 HRC

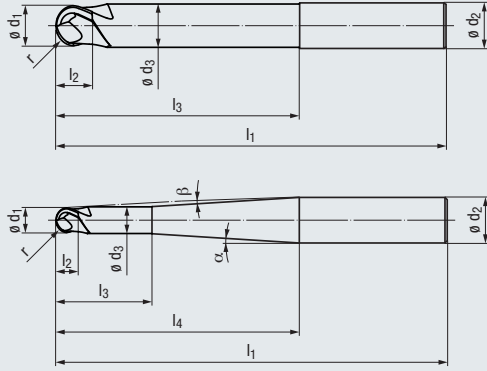

new

new



高硬度鋼

高硬度鋼

コーティング · Coating

アプリケーション - 被削材 (P4参照)

Applications - material (see page 4)

- 高硬度鋼加工用に新しく開発された特別な TIALN-コーティングを採用
- 荒加工、仕上げ加工とHSC高速仕上げ加工に最適

- Special TiAlN-coating for machining hardened materials
- Suitable for roughing, finishing and HSC finishing

TIALN

TIALN

P	3.1-5.1	1.1-2.1	P	3.1-5.1	1.1-2.1
K	1.1-4.2		K	1.1-4.2	
H	1.1-1.5		H	1.1-1.5	

l₃ = 1,5 x d₁ - エクストラショート · Extra short design

製品型番 · Order code

3826A

∅ d ₁	r	l ₂	l ₃	l ₁	∅ d ₃	l ₄	∅ d ₂ h4	α	β	Z (刃数)	サイズ 型番
-0.014	-0.007										
0,5	0,25	0,5	0,75	54	0,45	16,4	6	10°	10°	2	.0005
1	0,5	1	1,5	54	0,95	15,8	6	10°	9,5°	2	.001
1,5	0,75	1,5	2,25	54	1,4	15,3	6	10°	9°	2	.0015
2	1	2	3	54	1,8	14,9	6	10°	8°	2	.002
3	1,5	3	4,5	54	2,8	13,5	6	10°	7°	2	.003

l₃ = 3 x d₁ - ショート · Short design

製品型番 · Order code

3827A

∅ d ₁	r	l ₂	l ₃	l ₁	∅ d ₃	l ₄	∅ d ₂ h4	α	β	Z (刃数)	サイズ 型番
-0.014	-0.007										
0,5	0,25	1	2	54	0,45	17,7	6	10°	9°	2	.0005
1	0,5	2	4	57	0,95	18,3	6	10°	8,5°	2	.001
1,5	0,75	2,5	4,5	57	1,4	17,5	6	10°	8,5°	2	.0015
2	1	3	8	57	1,8	19,9	6	10°	6,5°	2	.002
3	1,5	3,5	10	57	2,8	19	6	10°	5,5°	2	.003
4	2	4	12	57	3,8	18,2	6	10°	3,5°	2	.004
5	2,5	5	15	57	4,7	18,6	6	10°	2	2	.005
6	3	6	20	57	5,6	-	6	-	-	2	.006
8	4	7	25	63	7,6	-	8	-	-	2	.008
10	5	8	30	72	9,6	-	10	-	-	2	.010
12	6	10	36	83	11,5	-	12	-	-	2	.012



超硬ソリッド ボールエンドミル - エクストラショートおよびショート (2 枚刃)
Solid carbide ball nose end mills - extra short and short design (2 flutes)

H

$l_3 = 1,5 \times d_1 \cdot l_3 = 3 \times d_1$

荒加工
Roughing

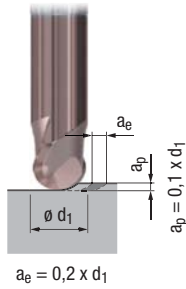

中仕上げ加工
Pre-finishing

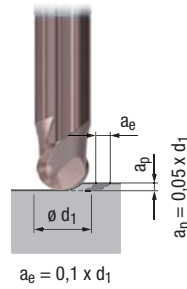

仕上げ加工
Finishing

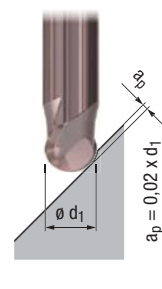

対象製品 · Valid for
3826A
3827A

	切削速度 v_c [m/min]	刃あたり送り f_z [mm]	切削速度 v_c [m/min]	刃あたり送り f_z [mm]	切削速度 v_c [m/min]	刃あたり送り f_z [mm]
--	-----------------------	----------------------	-----------------------	----------------------	-----------------------	----------------------



鋼 · Steel materials											
P	1.1	260	$0,013 \times d_1$	320	$0,015 \times d_1$	360	$0,013 \times d_1$	<input type="checkbox"/>	<input checked="" type="checkbox"/>	<input type="checkbox"/>	<input checked="" type="checkbox"/>
	2.1	240	$0,012 \times d_1$	280	$0,014 \times d_1$	320	$0,012 \times d_1$	<input type="checkbox"/>	<input checked="" type="checkbox"/>	<input type="checkbox"/>	<input checked="" type="checkbox"/>
	3.1	220	$0,011 \times d_1$	240	$0,013 \times d_1$	280	$0,011 \times d_1$	<input type="checkbox"/>	<input checked="" type="checkbox"/>	<input type="checkbox"/>	<input type="checkbox"/>
	4.1	200	$0,010 \times d_1$	220	$0,012 \times d_1$	240	$0,010 \times d_1$	<input type="checkbox"/>	<input checked="" type="checkbox"/>	<input type="checkbox"/>	<input type="checkbox"/>
	5.1	180	$0,009 \times d_1$	200	$0,010 \times d_1$	220	$0,009 \times d_1$	<input type="checkbox"/>	<input checked="" type="checkbox"/>	<input type="checkbox"/>	<input type="checkbox"/>
ステンレス · Stainless steel materials											
M	1.1										
	2.1										
	3.1										
	4.1										
鋳鉄 · Cast materials											
K	1.1	260	$0,011 \times d_1$	320	$0,013 \times d_1$	360	$0,010 \times d_1$	<input type="checkbox"/>	<input checked="" type="checkbox"/>	<input type="checkbox"/>	<input type="checkbox"/>
	1.2	260	$0,011 \times d_1$	320	$0,013 \times d_1$	360	$0,010 \times d_1$	<input type="checkbox"/>	<input checked="" type="checkbox"/>	<input type="checkbox"/>	<input type="checkbox"/>
	2.1	240	$0,011 \times d_1$	280	$0,013 \times d_1$	320	$0,010 \times d_1$	<input type="checkbox"/>	<input checked="" type="checkbox"/>	<input type="checkbox"/>	<input type="checkbox"/>
	2.2	240	$0,011 \times d_1$	280	$0,013 \times d_1$	320	$0,010 \times d_1$	<input type="checkbox"/>	<input checked="" type="checkbox"/>	<input type="checkbox"/>	<input type="checkbox"/>
	3.1	220	$0,010 \times d_1$	240	$0,011 \times d_1$	270	$0,008 \times d_1$	<input type="checkbox"/>	<input checked="" type="checkbox"/>	<input type="checkbox"/>	<input type="checkbox"/>
	3.2	220	$0,010 \times d_1$	240	$0,011 \times d_1$	270	$0,008 \times d_1$	<input type="checkbox"/>	<input checked="" type="checkbox"/>	<input type="checkbox"/>	<input type="checkbox"/>
	4.1	200	$0,008 \times d_1$	220	$0,009 \times d_1$	240	$0,007 \times d_1$	<input type="checkbox"/>	<input checked="" type="checkbox"/>	<input type="checkbox"/>	<input type="checkbox"/>
4.2	180	$0,008 \times d_1$	200	$0,009 \times d_1$	220	$0,007 \times d_1$	<input type="checkbox"/>	<input checked="" type="checkbox"/>	<input type="checkbox"/>	<input type="checkbox"/>	
非鉄 · Non-ferrous materials											
アルミニウム合金 · Aluminium alloys											
N	1.1										
	1.2										
	1.3										
	1.4										
	1.5										
	1.6										
	銅合金 · Copper alloys										
	2.1										
	2.2										
	2.3										
	2.4										
	2.5										
	2.6										
	2.7										
	2.8										
	マグネシウム合金 · Magnesium alloys										
3.1											
3.2											
合成樹脂 · Synthetics											
4.1											
4.2											
4.3											
4.4											
特殊合金 · Special materials											
5.1											
5.2											
5.3											
耐熱合金 · Special materials											
チタン合金 · Titanium alloys											
S	1.1										
	1.2										
	1.3										
	ニッケル基、コバルト基、鉄基合金 · Nickel alloys, cobalt alloys and iron alloys										
	2.1										
	2.2										
	2.3										
2.4											
2.5											
2.6											
高硬度鋼 · Hard materials											
H	1.1	160	$0,008 \times d_1$	200	$0,009 \times d_1$	220	$0,009 \times d_1$	<input type="checkbox"/>	<input checked="" type="checkbox"/>	<input type="checkbox"/>	<input type="checkbox"/>
	1.2	120	$0,007 \times d_1$	180	$0,008 \times d_1$	200	$0,008 \times d_1$	<input type="checkbox"/>	<input checked="" type="checkbox"/>	<input type="checkbox"/>	<input type="checkbox"/>
	1.3			160	$0,008 \times d_1$	180	$0,008 \times d_1$	<input type="checkbox"/>	<input checked="" type="checkbox"/>	<input type="checkbox"/>	<input type="checkbox"/>
	1.4			140	$0,007 \times d_1$	160	$0,007 \times d_1$	<input type="checkbox"/>	<input checked="" type="checkbox"/>	<input type="checkbox"/>	<input type="checkbox"/>
	1.5			120	$0,006 \times d_1$	140	$0,006 \times d_1$	<input type="checkbox"/>	<input checked="" type="checkbox"/>	<input type="checkbox"/>	<input type="checkbox"/>

v_c = 切削速度 · Cutting speed
 f_z = 刃あたり送り · Feed per tooth

■ = 最適 · very suitable
□ = 適用可能 · suitable

- ハイパフォーマンスツール
- 最適化されたチゼルエッジ設計
- より厳しいR公差
- 4種類の工具長さ
- h4公差の高精度シャンク

- High performance tool
- Optimised chisel edge
- High-precision radius
- 4 lengths available
- Highly precise straight shank with tolerance h4

H

超硬

DIN 6535
HA
HB

30°

ボール

1-3°

≤ 66 HRC



new



高硬度鋼

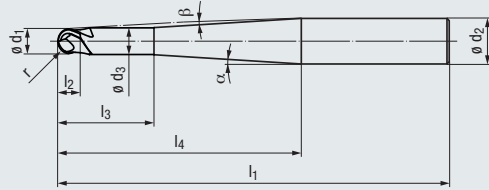
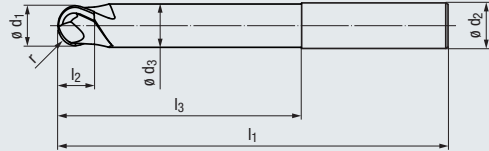

コーティング · Coating

アプリケーション - 被削材 (P4参照)

- 高硬度鋼加工用に新しく開発された特別な TIALN-コーティングを採用
- 荒加工、仕上げ加工とHSC高速仕上げ加工に最適

Applications - material (see page 4)

- Special TiAlN-coating for machining hardened materials
- Suitable for roughing, finishing and HSC finishing

TIALN

P	3.1-5.1	1.1-2.1
K	1.1-4.2	
H	1.1-1.5	

$l_3 = 5 \times d_1$ - ロング · Long design

製品型番 · Order code

ϕd_1	r	l_2	l_3	l_1	ϕd_3	l_4	ϕd_2	α	β	Z (刃数)	サイズ 型番	3828A
-0.014	-0.007						h4					
0,5	0,25	1	2,5	57	0,45	18,2	6	10°	9°	2	.0005	●
1	0,5	2	5	57	0,95	19,3	6	10°	8°	2	.001	●
1,5	0,75	2,5	7,5	57	1,4	20,5	6	10°	6,5°	2	.0015	●
2	1	3	10	63	1,8	21,9	6	10°	5,5°	2	.002	●
3	1,5	3,5	15	63	2,8	24	6	10°	4°	2	.003	●
4	2	4	20	63	3,8	26,2	6	10°	2,5°	2	.004	●
5	2,5	5	25	66	4,7	28,6	6	10°	1,5°	2	.005	●
6	3	6	30	68	5,6	-	6	-	-	2	.006	●
8	4	7	40	78	7,6	-	8	-	-	2	.008	●
10	5	8	50	92	9,6	-	10	-	-	2	.010	●
12	6	10	60	106	11,5	-	12	-	-	2	.012	●

超硬ソリッド ボールエンドミル - ロング (2 枚刃)
Solid carbide ball nose end mills - long design (2 flutes)

対象製品 · Valid for
3828A



H

$l_3 = 5 \times d_1$

荒加工
Roughing

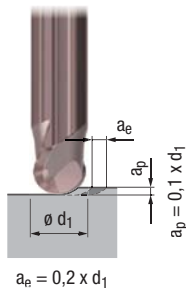

中仕上げ加工
Pre-finishing

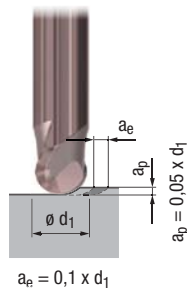

仕上げ加工
Finishing

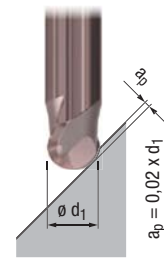

		切削速度 v_c [m/min]	刃あたり送り f_z [mm]	切削速度 v_c [m/min]	刃あたり送り f_z [mm]	切削速度 v_c [m/min]	刃あたり送り f_z [mm]			MMS MQL		
鋼 · Steel materials												
P	1.1	240	$0,013 \times d_1$	300	$0,015 \times d_1$	340	$0,013 \times d_1$	<input type="checkbox"/>	<input checked="" type="checkbox"/>	<input type="checkbox"/>	<input checked="" type="checkbox"/>	
	2.1	220	$0,012 \times d_1$	260	$0,014 \times d_1$	340	$0,012 \times d_1$	<input type="checkbox"/>	<input checked="" type="checkbox"/>	<input type="checkbox"/>	<input checked="" type="checkbox"/>	
	3.1	200	$0,011 \times d_1$	220	$0,013 \times d_1$	260	$0,011 \times d_1$	<input type="checkbox"/>	<input checked="" type="checkbox"/>	<input type="checkbox"/>	<input type="checkbox"/>	
	4.1	180	$0,010 \times d_1$	200	$0,012 \times d_1$	220	$0,010 \times d_1$	<input type="checkbox"/>	<input checked="" type="checkbox"/>	<input type="checkbox"/>	<input type="checkbox"/>	
	5.1	160	$0,009 \times d_1$	180	$0,010 \times d_1$	200	$0,009 \times d_1$	<input type="checkbox"/>	<input checked="" type="checkbox"/>	<input type="checkbox"/>	<input type="checkbox"/>	
ステンレス · Stainless steel materials												
M	1.1											
	2.1											
	3.1											
	4.1											
鋳鉄 · Cast materials												
K	1.1	240	$0,011 \times d_1$	300	$0,013 \times d_1$	340	$0,010 \times d_1$	<input type="checkbox"/>	<input checked="" type="checkbox"/>	<input type="checkbox"/>	<input type="checkbox"/>	
	1.2	240	$0,011 \times d_1$	300	$0,013 \times d_1$	340	$0,010 \times d_1$	<input type="checkbox"/>	<input checked="" type="checkbox"/>	<input type="checkbox"/>	<input type="checkbox"/>	
	2.1	220	$0,011 \times d_1$	260	$0,013 \times d_1$	300	$0,010 \times d_1$	<input type="checkbox"/>	<input checked="" type="checkbox"/>	<input type="checkbox"/>	<input type="checkbox"/>	
	2.2	220	$0,011 \times d_1$	260	$0,013 \times d_1$	300	$0,010 \times d_1$	<input type="checkbox"/>	<input checked="" type="checkbox"/>	<input type="checkbox"/>	<input type="checkbox"/>	
	3.1	200	$0,010 \times d_1$	220	$0,011 \times d_1$	250	$0,008 \times d_1$	<input type="checkbox"/>	<input checked="" type="checkbox"/>	<input type="checkbox"/>	<input type="checkbox"/>	
	3.2	200	$0,010 \times d_1$	220	$0,011 \times d_1$	250	$0,008 \times d_1$	<input type="checkbox"/>	<input checked="" type="checkbox"/>	<input type="checkbox"/>	<input type="checkbox"/>	
	4.1	180	$0,008 \times d_1$	200	$0,009 \times d_1$	220	$0,007 \times d_1$	<input type="checkbox"/>	<input checked="" type="checkbox"/>	<input type="checkbox"/>	<input type="checkbox"/>	
	4.2	160	$0,008 \times d_1$	180	$0,009 \times d_1$	200	$0,007 \times d_1$	<input type="checkbox"/>	<input checked="" type="checkbox"/>	<input type="checkbox"/>	<input type="checkbox"/>	
非鉄 · Non-ferrous materials												
アルミニウム合金 · Aluminium alloys												
N	1.1											
	1.2											
	1.3											
	1.4											
	1.5											
	1.6											
	銅合金 · Copper alloys											
	2.1											
	2.2											
	2.3											
	2.4											
	2.5											
	2.6											
	2.7											
	2.8											
	マグネシウム合金 · Magnesium alloys											
3.1												
3.2												
合成樹脂 · Synthetics												
4.1												
4.2												
4.3												
4.4												
特殊合金 · Special materials												
5.1												
5.2												
5.3												
耐熱合金 · Special materials												
チタン合金 · Titanium alloys												
1.1												
1.2												
1.3												
S	ニッケル基、コバルト基、鉄基合金 · Nickel alloys, cobalt alloys and iron alloys											
	2.1											
	2.2											
	2.3											
	2.4											
	2.5											
2.6												
高硬度鋼 · Hard materials												
H	1.1	140	$0,008 \times d_1$	180	$0,009 \times d_1$	200	$0,009 \times d_1$	<input type="checkbox"/>	<input checked="" type="checkbox"/>	<input type="checkbox"/>	<input type="checkbox"/>	
	1.2	110	$0,007 \times d_1$	160	$0,008 \times d_1$	180	$0,008 \times d_1$	<input type="checkbox"/>	<input checked="" type="checkbox"/>	<input type="checkbox"/>	<input type="checkbox"/>	
	1.3			140	$0,008 \times d_1$	160	$0,008 \times d_1$	<input type="checkbox"/>	<input checked="" type="checkbox"/>	<input type="checkbox"/>	<input type="checkbox"/>	
	1.4			130	$0,007 \times d_1$	140	$0,007 \times d_1$	<input type="checkbox"/>	<input checked="" type="checkbox"/>	<input type="checkbox"/>	<input type="checkbox"/>	
	1.5			110	$0,006 \times d_1$	130	$0,006 \times d_1$	<input type="checkbox"/>	<input checked="" type="checkbox"/>	<input type="checkbox"/>	<input type="checkbox"/>	

v_c = 切削速度 · Cutting speed
 f_z = 刃あたり送り · Feed per tooth

■ = 最適 · very suitable
□ = 適用可能 · suitable

- ハイパフォーマンスツール
- 最適化されたチゼルエッジ設計
- より厳しいR公差
- 4種類の工具長さ
- h4公差の高精度シャンク

- High performance tool
- Optimised chisel edge
- High-precision radius
- 4 lengths available
- Highly precise straight shank with tolerance h4

H

超硬

DIN 6535
HA
HB

30°

ボール

1-3°

≤ 66
HRC



new



高硬度鋼

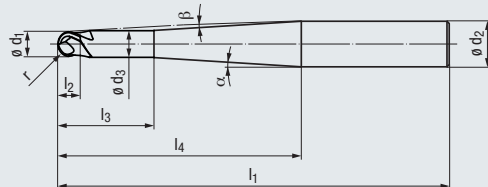
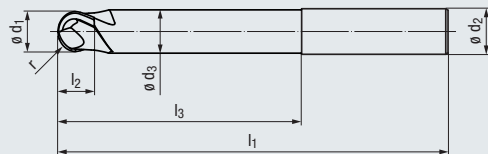

コーティング · Coating

アプリケーション - 被削材 (P4参照)

- 高硬度鋼加工用に新しく開発された特別な TIALN-コーティングを採用
- 荒加工、仕上げ加工とHSC高速仕上げ加工に最適

Applications - material (see page 4)

- Special TIALN-coating for machining hardened materials
- Suitable for pre-finishing, finishing and HSC finishing

TIALN

P	3.1-5.1	1.1-2.1
K	1.1-4.2	
H	1.1-1.5	

$l_3 = 8 \times d_1$ - エクストラロング · Extra long design

製品型番 · Order code

$\varnothing d_1$	r	l_2	l_3	l_1	$\varnothing d_3$	l_4	$\varnothing d_2$ h4	α	β	Z (刃数)	サイズ 型番	3829A
0,5	0,25	1	4	57	0,45	19,7	6	10°	8°	2	.0005	●
1	0,5	2	8	60	0,95	22,3	6	10°	6,5°	2	.001	●
1,5	0,75	2,5	12	63	1,4	25	6	10°	5,5°	2	.0015	●
2	1	3	16	66	1,8	27,9	6	10°	4,5°	2	.002	●
3	1,5	3,5	24	72	2,8	33	6	10°	3°	2	.003	●
4	2	4	32	76	3,8	38,2	6	10°	2°	2	.004	●
5	2,5	5	40	80	4,7	43,6	6	10°	1°	2	.005	●
6	3	6	48	86	5,6	-	6	-	-	2	.006	●
8	4	7	64	102	7,6	-	8	-	-	2	.008	●



超硬ソリッド ボールエンドミル - エクストラロング (2 枚刃)
Solid carbide ball nose end mills - extra long design (2 flutes)

H

$$l_3 = 8 \times d_1$$

中仕上げ加工
Pre-finishing

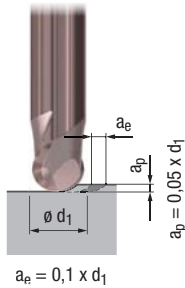

仕上げ加工
Finishing

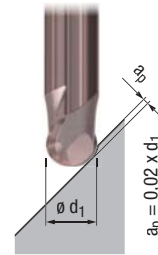

対象製品 · Valid for
3829A

	切削速度 v_c [m/min]	刃あたり送り f_z [mm]	切削速度 v_c [m/min]	刃あたり送り f_z [mm]			MMS MQL		
鋼 · Steel materials									
P	1.1	240	$0,013 \times d_1$	280	$0,013 \times d_1$	<input type="checkbox"/>	<input checked="" type="checkbox"/>	<input type="checkbox"/>	
	2.1	220	$0,012 \times d_1$	260	$0,012 \times d_1$	<input type="checkbox"/>	<input checked="" type="checkbox"/>	<input type="checkbox"/>	
	3.1	200	$0,011 \times d_1$	240	$0,011 \times d_1$	<input type="checkbox"/>	<input checked="" type="checkbox"/>	<input type="checkbox"/>	
	4.1	180	$0,010 \times d_1$	210	$0,010 \times d_1$	<input type="checkbox"/>	<input checked="" type="checkbox"/>	<input type="checkbox"/>	
	5.1	160	$0,009 \times d_1$	190	$0,009 \times d_1$	<input type="checkbox"/>	<input checked="" type="checkbox"/>	<input type="checkbox"/>	
ステンレス · Stainless steel materials									
M	1.1								
	2.1								
	3.1								
	4.1								
鋳鉄 · Cast materials									
K	1.1	240	$0,011 \times d_1$	280	$0,010 \times d_1$	<input type="checkbox"/>	<input checked="" type="checkbox"/>	<input type="checkbox"/>	
	1.2	240	$0,011 \times d_1$	280	$0,010 \times d_1$	<input type="checkbox"/>	<input checked="" type="checkbox"/>	<input type="checkbox"/>	
	2.1	220	$0,011 \times d_1$	260	$0,010 \times d_1$	<input type="checkbox"/>	<input checked="" type="checkbox"/>	<input type="checkbox"/>	
	2.2	220	$0,011 \times d_1$	260	$0,010 \times d_1$	<input type="checkbox"/>	<input checked="" type="checkbox"/>	<input type="checkbox"/>	
	3.1	200	$0,010 \times d_1$	240	$0,008 \times d_1$	<input type="checkbox"/>	<input checked="" type="checkbox"/>	<input type="checkbox"/>	
	3.2	200	$0,010 \times d_1$	240	$0,008 \times d_1$	<input type="checkbox"/>	<input checked="" type="checkbox"/>	<input type="checkbox"/>	
	4.1	180	$0,008 \times d_1$	210	$0,007 \times d_1$	<input type="checkbox"/>	<input checked="" type="checkbox"/>	<input type="checkbox"/>	
	4.2	160	$0,008 \times d_1$	190	$0,007 \times d_1$	<input type="checkbox"/>	<input checked="" type="checkbox"/>	<input type="checkbox"/>	
非鉄 · Non-ferrous materials									
アルミニウム合金 · Aluminium alloys									
N	1.1								
	1.2								
	1.3								
	1.4								
	1.5								
	1.6								
	銅合金 · Copper alloys								
	2.1								
	2.2								
	2.3								
	2.4								
	2.5								
	2.6								
	2.7								
	2.8								
	マグネシウム合金 · Magnesium alloys								
3.1									
3.2									
合成樹脂 · Synthetics									
4.1									
4.2									
4.3									
4.4									
特殊合金 · Special materials									
5.1									
5.2									
5.3									
耐熱合金 · Special materials									
チタン合金 · Titanium alloys									
S	1.1								
	1.2								
	1.3								
	ニッケル基、コバルト基、鉄基合金 · Nickel alloys, cobalt alloys and iron alloys								
	2.1								
	2.2								
	2.3								
2.4									
2.5									
2.6									
高硬度鋼 · Hard materials									
H	1.1	140	$0,008 \times d_1$	180	$0,009 \times d_1$	<input type="checkbox"/>	<input checked="" type="checkbox"/>	<input type="checkbox"/>	
	1.2	120	$0,007 \times d_1$	160	$0,008 \times d_1$	<input type="checkbox"/>	<input checked="" type="checkbox"/>	<input type="checkbox"/>	
	1.3	110	$0,008 \times d_1$	140	$0,008 \times d_1$	<input type="checkbox"/>	<input checked="" type="checkbox"/>	<input type="checkbox"/>	
	1.4	100	$0,007 \times d_1$	120	$0,007 \times d_1$	<input type="checkbox"/>	<input checked="" type="checkbox"/>	<input type="checkbox"/>	
	1.5	80	$0,006 \times d_1$	100	$0,006 \times d_1$	<input type="checkbox"/>	<input checked="" type="checkbox"/>	<input type="checkbox"/>	

v_c = 切削速度 · Cutting speed
 f_z = 刃あたり送り · Feed per tooth

■ = 最適 · very suitable
□ = 適用可能 · suitable

- ハイパフォーマンスツール
- 最適化されたチゼルエッジ設計
- 4 枚刃
- 中心刃は 2 枚刃
- より厳しいR公差
- 3 種類の工具長さ
- h4 公差の高精度シャンク

- High performance tool
- Optimised chisel edge design
- With 4 flutes
- 2 centre cutting edges
- High-precision radius
- 3 lengths available
- Highly precise straight shank with tolerance h4

H

超硬

DIN 6535
HA
HB

30°
ボール

1-3°

≤ 66
HRC



NEW



高硬度鋼

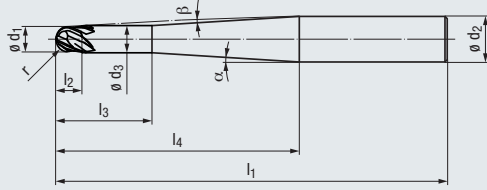
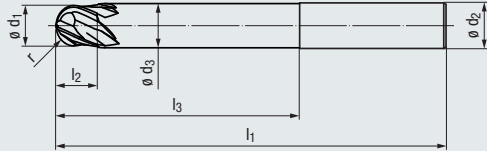

コーティング · Coating

アプリケーション - 被削材 (P4参照)

- 高硬度鋼加工用に新しく開発された特別な TIALN-コーティングを採用
- 中仕上げ加工、仕上げ加工とHSC高速仕上げ加工に最適

Applications - material (see page 4)

- Special TiAlN-coating for machining hardened materials
- Suitable for pre-finishing, finishing and HSC finishing

TIALN

P	3.1-5.1	1.1-2.1
K	1.1-4.2	
H	1.1-1.5	

$l_3 = 3 \times d_1$ - ショート · Short design

製品型番 · Order code

3831A

ϕd_1	r	l_2	l_3	l_1	ϕd_3	l_4	ϕd_2 h4	α	β	Z (刃数)	サイズ 型番		
-0.014	-0.007												
2	1	3	8	57	1,8	19,9	6	10°	6,5°	4	.002	●	
3	1,5	3,5	10	57	2,8	19	6	10°	5,5°	4	.003	●	
4	2	4	12	57	3,8	18,2	6	10°	3,5°	4	.004	●	
5	2,5	5	15	57	4,7	18,6	6	10°	2°	4	.005	●	
6	3	6	20	57	5,6	-	6	-	-	4	.006	●	
8	4	7	25	63	7,6	-	8	-	-	4	.008	●	
10	5	8	30	72	9,6	-	10	-	-	4	.010	●	
12	6	10	36	83	11,5	-	12	-	-	4	.012	●	



15-90° すべての切刃が有効
All cutting edges in operation

0-15° 有効刃数 2枚
2 cutting edges in operation



超硬ソリッド ボールエンドミル - ショート (4 枚刃)
Solid carbide ball nose end mills – short design (4 flutes)

対象製品 · Valid for
3831A

H

$l_3 = 3 \times d_1$

中仕上げ加工
Pre-finishing

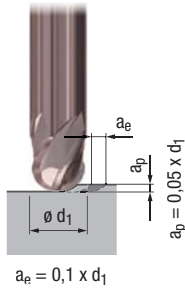

仕上げ加工
Finishing

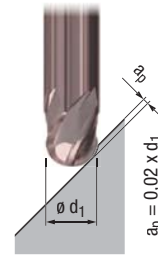

		切削速度 v_c [m/min]	刃あたり送り f_z [mm]	切削速度 v_c [m/min]	刃あたり送り f_z [mm]			MMS MQL		
鋼 · Steel materials										
P	1.1	320	$0.015 \times d_1$	360	$0.013 \times d_1$	<input type="checkbox"/>	<input checked="" type="checkbox"/>	<input type="checkbox"/>	<input checked="" type="checkbox"/>	
	2.1	280	$0.014 \times d_1$	320	$0.012 \times d_1$	<input type="checkbox"/>	<input checked="" type="checkbox"/>	<input type="checkbox"/>	<input checked="" type="checkbox"/>	
	3.1	240	$0.013 \times d_1$	280	$0.011 \times d_1$	<input type="checkbox"/>	<input checked="" type="checkbox"/>	<input type="checkbox"/>	<input type="checkbox"/>	
	4.1	220	$0.012 \times d_1$	240	$0.010 \times d_1$	<input type="checkbox"/>	<input checked="" type="checkbox"/>	<input type="checkbox"/>	<input type="checkbox"/>	
	5.1	200	$0.010 \times d_1$	220	$0.009 \times d_1$	<input type="checkbox"/>	<input checked="" type="checkbox"/>	<input type="checkbox"/>	<input type="checkbox"/>	
ステンレス · Stainless steel materials										
M	1.1									
	2.1									
	3.1									
	4.1									
鋳鉄 · Cast materials										
K	1.1	320	$0.013 \times d_1$	360	$0.010 \times d_1$	<input type="checkbox"/>	<input checked="" type="checkbox"/>		<input type="checkbox"/>	
	1.2	320	$0.013 \times d_1$	360	$0.010 \times d_1$	<input type="checkbox"/>	<input checked="" type="checkbox"/>		<input type="checkbox"/>	
	2.1	280	$0.013 \times d_1$	320	$0.010 \times d_1$	<input type="checkbox"/>	<input checked="" type="checkbox"/>		<input type="checkbox"/>	
	2.2	280	$0.013 \times d_1$	320	$0.010 \times d_1$	<input type="checkbox"/>	<input checked="" type="checkbox"/>		<input type="checkbox"/>	
	3.1	240	$0.011 \times d_1$	270	$0.008 \times d_1$	<input type="checkbox"/>	<input checked="" type="checkbox"/>		<input type="checkbox"/>	
	3.2	240	$0.011 \times d_1$	270	$0.008 \times d_1$	<input type="checkbox"/>	<input checked="" type="checkbox"/>		<input type="checkbox"/>	
	4.1	220	$0.009 \times d_1$	240	$0.007 \times d_1$	<input type="checkbox"/>	<input checked="" type="checkbox"/>		<input type="checkbox"/>	
	4.2	200	$0.009 \times d_1$	220	$0.007 \times d_1$	<input type="checkbox"/>	<input checked="" type="checkbox"/>		<input type="checkbox"/>	
非鉄 · Non-ferrous materials										
アルミニウム合金 · Aluminium alloys										
N	1.1									
	1.2									
	1.3									
	1.4									
	1.5									
	1.6									
	銅合金 · Copper alloys									
	2.1									
	2.2									
	2.3									
	2.4									
	2.5									
	2.6									
	2.7									
	2.8									
	マグネシウム合金 · Magnesium alloys									
3.1										
3.2										
合成樹脂 · Synthetics										
4.1										
4.2										
4.3										
4.4										
特殊合金 · Special materials										
5.1										
5.2										
5.3										
耐熱合金 · Special materials										
チタン合金 · Titanium alloys										
1.1										
1.2										
1.3										
S	ニッケル基、コバルト基、鉄基合金 · Nickel alloys, cobalt alloys and iron alloys									
	2.1									
	2.2									
	2.3									
	2.4									
	2.5									
2.6										
高硬度鋼 · Hard materials										
H	1.1	200	$0.009 \times d_1$	220	$0.009 \times d_1$	<input type="checkbox"/>	<input checked="" type="checkbox"/>		<input type="checkbox"/>	
	1.2	180	$0.008 \times d_1$	200	$0.008 \times d_1$	<input type="checkbox"/>	<input checked="" type="checkbox"/>		<input type="checkbox"/>	
	1.3	160	$0.008 \times d_1$	180	$0.008 \times d_1$	<input type="checkbox"/>	<input checked="" type="checkbox"/>		<input type="checkbox"/>	
	1.4	140	$0.007 \times d_1$	160	$0.007 \times d_1$	<input type="checkbox"/>	<input checked="" type="checkbox"/>		<input type="checkbox"/>	
	1.5	120	$0.006 \times d_1$	140	$0.006 \times d_1$	<input type="checkbox"/>	<input checked="" type="checkbox"/>		<input type="checkbox"/>	

v_c = 切削速度 · Cutting speed
 f_z = 刃あたり送り · Feed per tooth

■ = 最適 · very suitable
□ = 適用可能 · suitable

- ハイパフォーマンスツール
- 最適化されたチゼルエッジ設計
- 4 枚刃
- 中心刃は 2 枚刃
- より厳しいR公差
- 3 種類の工具長さ
- h4 公差の高精度シャンク

- High performance tool
- Optimised chisel edge design
- With 4 flutes
- 2 centre cutting edges
- High-precision radius
- 3 lengths available
- Highly precise straight shank with tolerance h4



NEW



高硬度鋼

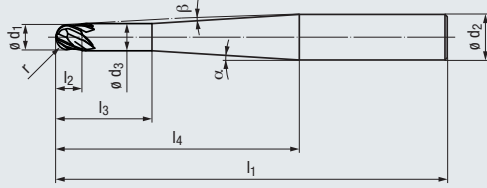
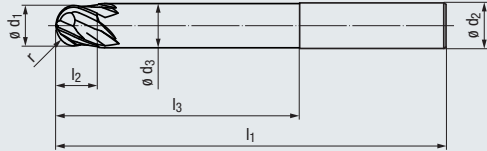

コーティング · Coating

アプリケーション - 被削材 (P4参照)

- 高硬度鋼加工用に新しく開発された特別な TiAlN-コーティングを採用
- 中仕上げ加工、仕上げ加工とHSC高速仕上げ加工に最適

Applications - material (see page 4)

- Special TiAlN-coating for machining hardened materials
- Suitable for pre-finishing, finishing and HSC finishing

TiAlN

P	3.1-5.1	1.1-2.1
K	1.1-4.2	
H	1.1-1.5	

$l_3 = 5 \times d_1$ - ロング · Long design

製品型番 · Order code

ϕd_1	r	l_2	l_3	l_1	ϕd_3	l_4	ϕd_2 h4	α	β	Z (刃数)	サイズ 型番	3832A
-0.014	-0.007											
2	1	3	10	63	1.8	21.9	6	10°	5.5°	4	.002	●
3	1.5	3.5	15	63	2.8	24	6	10°	4°	4	.003	●
4	2	4	20	63	3.8	26.2	6	10°	2.5°	4	.004	●
5	2.5	5	25	66	4.7	28.6	6	10°	1.5°	4	.005	●
6	3	6	30	68	5.6	-	6	-	-	4	.006	●
8	4	7	40	78	7.6	-	8	-	-	4	.008	●
10	5	8	50	92	9.6	-	10	-	-	4	.010	●
12	6	10	60	106	11.5	-	12	-	-	4	.012	●



15-90° すべての切刃が有効
All cutting edges in operation

0-15° 有効刃数 2枚
2 cutting edges in operation



超硬ソリッド ボールエンドミル-ロング (4 枚刃)
Solid carbide ball nose end mills – long design (4 flutes)

H

$l_3 = 5 \times d_1$

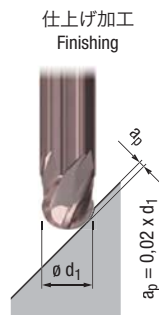
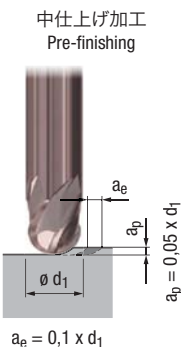

対象製品 · Valid for
3832A

		切削速度 v_c [m/min]	刃あたり送り f_z [mm]	切削速度 v_c [m/min]	刃あたり送り f_z [mm]			MMS MQL		
鋼 · Steel materials										
P	1.1	300	$0.015 \times d_1$	340	$0.013 \times d_1$	<input type="checkbox"/>	<input checked="" type="checkbox"/>	<input type="checkbox"/>	<input checked="" type="checkbox"/>	
	2.1	260	$0.014 \times d_1$	340	$0.012 \times d_1$	<input type="checkbox"/>	<input checked="" type="checkbox"/>	<input type="checkbox"/>	<input checked="" type="checkbox"/>	
	3.1	220	$0.013 \times d_1$	260	$0.011 \times d_1$	<input type="checkbox"/>	<input checked="" type="checkbox"/>	<input type="checkbox"/>	<input type="checkbox"/>	
	4.1	200	$0.012 \times d_1$	220	$0.010 \times d_1$	<input type="checkbox"/>	<input checked="" type="checkbox"/>	<input type="checkbox"/>	<input type="checkbox"/>	
	5.1	180	$0.010 \times d_1$	200	$0.009 \times d_1$	<input type="checkbox"/>	<input checked="" type="checkbox"/>	<input type="checkbox"/>	<input type="checkbox"/>	
ステンレス · Stainless steel materials										
M	1.1									
	2.1									
	3.1									
	4.1									
鋳鉄 · Cast materials										
K	1.1	300	$0.013 \times d_1$	340	$0.010 \times d_1$	<input type="checkbox"/>	<input checked="" type="checkbox"/>		<input type="checkbox"/>	
	1.2	300	$0.013 \times d_1$	340	$0.010 \times d_1$	<input type="checkbox"/>	<input checked="" type="checkbox"/>		<input type="checkbox"/>	
	2.1	260	$0.013 \times d_1$	300	$0.010 \times d_1$	<input type="checkbox"/>	<input checked="" type="checkbox"/>		<input type="checkbox"/>	
	2.2	260	$0.013 \times d_1$	300	$0.010 \times d_1$	<input type="checkbox"/>	<input checked="" type="checkbox"/>		<input type="checkbox"/>	
	3.1	220	$0.011 \times d_1$	250	$0.008 \times d_1$	<input type="checkbox"/>	<input checked="" type="checkbox"/>		<input type="checkbox"/>	
	3.2	220	$0.011 \times d_1$	250	$0.008 \times d_1$	<input type="checkbox"/>	<input checked="" type="checkbox"/>		<input type="checkbox"/>	
	4.1	200	$0.009 \times d_1$	220	$0.007 \times d_1$	<input type="checkbox"/>	<input checked="" type="checkbox"/>		<input type="checkbox"/>	
	4.2	180	$0.009 \times d_1$	200	$0.007 \times d_1$	<input type="checkbox"/>	<input checked="" type="checkbox"/>		<input type="checkbox"/>	
非鉄 · Non-ferrous materials										
アルミニウム合金 · Aluminium alloys										
N	1.1									
	1.2									
	1.3									
	1.4									
	1.5									
	1.6									
	銅合金 · Copper alloys									
	2.1									
	2.2									
	2.3									
	2.4									
	2.5									
	2.6									
	2.7									
	2.8									
	マグネシウム合金 · Magnesium alloys									
3.1										
3.2										
合成樹脂 · Synthetics										
4.1										
4.2										
4.3										
4.4										
特殊合金 · Special materials										
5.1										
5.2										
5.3										
耐熱合金 · Special materials										
チタン合金 · Titanium alloys										
S	1.1									
	1.2									
	1.3									
	ニッケル基、コバルト基、鉄基合金 · Nickel alloys, cobalt alloys and iron alloys									
	2.1									
	2.2									
	2.3									
2.4										
2.5										
2.6										
高硬度鋼 · Hard materials										
H	1.1	180	$0.009 \times d_1$	200	$0.009 \times d_1$	<input type="checkbox"/>	<input checked="" type="checkbox"/>		<input type="checkbox"/>	
	1.2	160	$0.008 \times d_1$	180	$0.008 \times d_1$	<input type="checkbox"/>	<input checked="" type="checkbox"/>		<input type="checkbox"/>	
	1.3	140	$0.008 \times d_1$	160	$0.008 \times d_1$	<input type="checkbox"/>	<input checked="" type="checkbox"/>		<input type="checkbox"/>	
	1.4	130	$0.007 \times d_1$	140	$0.007 \times d_1$	<input type="checkbox"/>	<input checked="" type="checkbox"/>		<input type="checkbox"/>	
	1.5	110	$0.006 \times d_1$	130	$0.006 \times d_1$	<input type="checkbox"/>	<input checked="" type="checkbox"/>		<input type="checkbox"/>	

v_c = 切削速度 · Cutting speed
 f_z = 刃あたり送り · Feed per tooth

■ = 最適 · very suitable
□ = 適用可能 · suitable

- ハイパフォーマンスツール
- 最適化されたチゼルエッジ設計
- 4 枚刃
- 中心刃は 2 枚刃
- より厳しいR公差
- 3 種類の工具長さ
- h4 公差の高精度シャンク

- High performance tool
- Optimised chisel edge design
- With 4 flutes
- 2 centre cutting edges
- High-precision radius
- 3 lengths available
- Highly precise straight shank with tolerance h4



超硬



ボール



1-3°



≤ 66 HRC



new



高硬度鋼

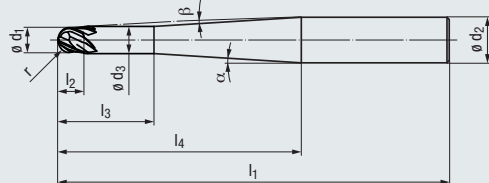
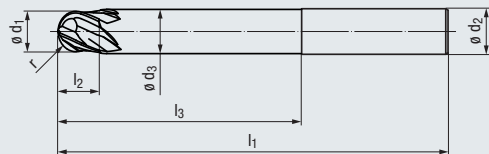

コーティング · Coating

アプリケーション - 被削材 (P4参照)

- 高硬度鋼加工用に新しく開発された特別な TIALN-コーティングを採用
- 中仕上げ加工、仕上げ加工とHSC高速仕上げ加工に最適

Applications - material (see page 4)

- Special TIALN-coating for machining hardened materials
- Suitable for pre-finishing, finishing and HSC finishing

TIALN

P	3.1-5.1	1.1-2.1
K	1.1-4.2	
H	1.1-1.5	

l₃ = 8 x d₁ - エクストラロング · Extra long design

製品型番 · Order code

∅ d ₁	r	l ₂	l ₃	l ₁	∅ d ₃	l ₄	∅ d ₂ h4	α	β	Z (刃数)	サイズ 型番	3833A
-0,014	-0,007											
2	1	3	16	66	1,8	27,9	6	10°	4,5°	4	.002	●
3	1,5	3,5	24	72	2,8	33	6	10°	3°	4	.003	●
4	2	4	32	76	3,8	38,2	6	10°	2°	4	.004	●
5	2,5	5	40	80	4,7	43,6	6	10°	1°	4	.005	●
6	3	6	48	86	5,6	-	6	-	-	4	.006	●
8	4	7	64	102	7,6	-	8	-	-	4	.008	●



15-90° すべての切刃が有効
All cutting edges in operation

0-15° 有効刃数 2枚
2 cutting edges in operation



超硬ソリッド ボールエンドミル - エクストラロング (4 枚刃)
Solid carbide ball nose end mills - extra long design (4 flutes)

対象製品 · Valid for
3833A

H

$l_3 = 8 \times d_1$

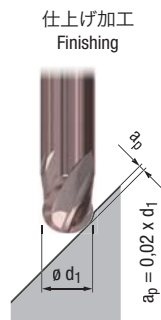
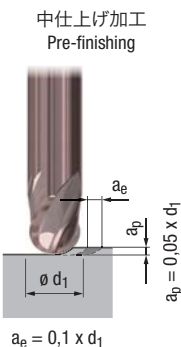

	切削速度 v_c [m/min]	刃あたり送り f_z [mm]	切削速度 v_c [m/min]	刃あたり送り f_z [mm]					
鋼 · Steel materials									
P	1.1	240	$0.013 \times d_1$	280	$0.013 \times d_1$	<input type="checkbox"/>	<input checked="" type="checkbox"/>	<input type="checkbox"/>	
	2.1	220	$0.012 \times d_1$	260	$0.012 \times d_1$	<input type="checkbox"/>	<input checked="" type="checkbox"/>	<input type="checkbox"/>	
	3.1	200	$0.011 \times d_1$	240	$0.011 \times d_1$	<input type="checkbox"/>	<input checked="" type="checkbox"/>	<input type="checkbox"/>	
	4.1	180	$0.010 \times d_1$	210	$0.010 \times d_1$	<input type="checkbox"/>	<input checked="" type="checkbox"/>	<input type="checkbox"/>	
	5.1	160	$0.009 \times d_1$	190	$0.009 \times d_1$	<input type="checkbox"/>	<input checked="" type="checkbox"/>	<input type="checkbox"/>	
ステンレス · Stainless steel materials									
M	1.1								
	2.1								
	3.1								
	4.1								
鋳鉄 · Cast materials									
K	1.1	240	$0.011 \times d_1$	280	$0.010 \times d_1$	<input type="checkbox"/>	<input checked="" type="checkbox"/>	<input type="checkbox"/>	
	1.2	240	$0.011 \times d_1$	280	$0.010 \times d_1$	<input type="checkbox"/>	<input checked="" type="checkbox"/>	<input type="checkbox"/>	
	2.1	220	$0.011 \times d_1$	260	$0.010 \times d_1$	<input type="checkbox"/>	<input checked="" type="checkbox"/>	<input type="checkbox"/>	
	2.2	220	$0.011 \times d_1$	260	$0.010 \times d_1$	<input type="checkbox"/>	<input checked="" type="checkbox"/>	<input type="checkbox"/>	
	3.1	200	$0.010 \times d_1$	240	$0.008 \times d_1$	<input type="checkbox"/>	<input checked="" type="checkbox"/>	<input type="checkbox"/>	
	3.2	200	$0.010 \times d_1$	240	$0.008 \times d_1$	<input type="checkbox"/>	<input checked="" type="checkbox"/>	<input type="checkbox"/>	
	4.1	180	$0.008 \times d_1$	210	$0.007 \times d_1$	<input type="checkbox"/>	<input checked="" type="checkbox"/>	<input type="checkbox"/>	
	4.2	160	$0.008 \times d_1$	190	$0.007 \times d_1$	<input type="checkbox"/>	<input checked="" type="checkbox"/>	<input type="checkbox"/>	
非鉄 · Non-ferrous materials									
アルミニウム合金 · Aluminium alloys									
N	1.1								
	1.2								
	1.3								
	1.4								
	1.5								
	1.6								
	銅合金 · Copper alloys								
	2.1								
	2.2								
	2.3								
	2.4								
	2.5								
	2.6								
	2.7								
	2.8								
	マグネシウム合金 · Magnesium alloys								
3.1									
3.2									
合成樹脂 · Synthetics									
4.1									
4.2									
4.3									
4.4									
特殊合金 · Special materials									
5.1									
5.2									
5.3									
耐熱合金 · Special materials									
チタン合金 · Titanium alloys									
S	1.1								
	1.2								
	1.3								
	ニッケル基、コバルト基、鉄基合金 · Nickel alloys, cobalt alloys and iron alloys								
	2.1								
	2.2								
	2.3								
2.4									
2.5									
2.6									
高硬度鋼 · Hard materials									
H	1.1	140	$0.008 \times d_1$	180	$0.009 \times d_1$	<input type="checkbox"/>	<input checked="" type="checkbox"/>	<input type="checkbox"/>	
	1.2	120	$0.007 \times d_1$	160	$0.008 \times d_1$	<input type="checkbox"/>	<input checked="" type="checkbox"/>	<input type="checkbox"/>	
	1.3	110	$0.008 \times d_1$	140	$0.008 \times d_1$	<input type="checkbox"/>	<input checked="" type="checkbox"/>	<input type="checkbox"/>	
	1.4	100	$0.007 \times d_1$	120	$0.007 \times d_1$	<input type="checkbox"/>	<input checked="" type="checkbox"/>	<input type="checkbox"/>	
	1.5	80	$0.006 \times d_1$	100	$0.006 \times d_1$	<input type="checkbox"/>	<input checked="" type="checkbox"/>	<input type="checkbox"/>	

v_c = 切削速度 · Cutting speed
 f_z = 刃あたり送り · Feed per tooth

■ = 最適 · very suitable
□ = 適用可能 · suitable

- ハイパフォーマンスツール
- 特許取得のチゼルエッジ設計
- 6 枚刃と 8 枚刃
- 中心刃は 2 枚刃
- 剛性の高い短フルート設計
- 2 種類の工具長さ

- High performance tool
- Patented chisel edge
- With 6 and 8 flutes
- 2 centre cutting edges
- Short, stable flute length
- 2 lengths available

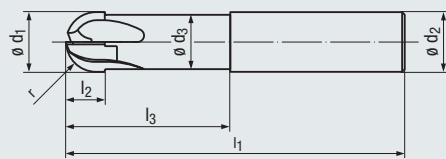

高硬度鋼



高硬度鋼

コーティング · Coating

アプリケーション - 被削材 (P4参照)

- 高硬度鋼の加工に
- 極めて高い面粗さを要求される仕上げ加工に
- HSC高速仕上げ加工に最適

Applications - material (see page 4)

- For machining hard materials
- For finishing with very high surface quality
- Suitable for HSC finishing

TIALN

TIALN

P	3.1-5.1	P	3.1-5.1
K	1.1-4.2	K	1.1-4.2
N	2.3, 2.6	N	2.3, 2.6
S	1.2-2.6	S	1.2-2.6
H	1.1-1.5	H	1.1-1.5

ショート · Short design

製品型番 · Order code

ϕd_1 $\pm 0,01$	r $\pm 0,005$	l_2	l_3	l_1	ϕd_3	ϕd_2 h5	Z (刃数)	サイズ 型番	2836A
10	5	6	30	72	9,6	10	6	.010	●
12	6	7	35	83	11,5	12	8	.012	●

ロング · Long design

製品型番 · Order code

ϕd_1 $\pm 0,01$	r $\pm 0,005$	l_2	l_3	l_1	ϕd_3	ϕd_2 h5	Z (刃数)	サイズ 型番	2837A
10	5	6	45	100	9,6	10	6	.010	●
12	6	7	50	100	11,5	12	8	.012	●
16	8	8	60	120	15,5	16	8	.016	●



15-90° すべての切刃が有効
All cutting edges in operation

0-15° 有効刃数 2枚
2 cutting edges in operation



超硬ソリッド ボールエンドミル - ショートおよびロング (6-8 枚刃)
Solid carbide ball nose end mills - short and long design (6-8 flutes)

H

仕上げ加工
Finishing

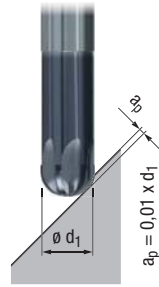

対象製品 · Valid for
2836A
2837A

切削速度
 v_c [m/min]

刃あたり送り
 f_z [mm]



鋼 · Steel materials							
P	1.1						
	2.1						
	3.1	270		0,007 x d_1	<input type="checkbox"/>	<input checked="" type="checkbox"/>	<input type="checkbox"/>
	4.1	220		0,006 x d_1	<input type="checkbox"/>	<input checked="" type="checkbox"/>	<input type="checkbox"/>
	5.1	180		0,0054 x d_1	<input type="checkbox"/>	<input checked="" type="checkbox"/>	<input type="checkbox"/>
ステンレス · Stainless steel materials							
M	1.1						
	2.1						
	3.1						
	4.1						
鋳鉄 · Cast materials							
K	1.1	360		0,008 x d_1	<input type="checkbox"/>	<input checked="" type="checkbox"/>	<input type="checkbox"/>
	1.2	360		0,008 x d_1	<input type="checkbox"/>	<input checked="" type="checkbox"/>	<input type="checkbox"/>
	2.1	320		0,006 x d_1	<input type="checkbox"/>	<input checked="" type="checkbox"/>	<input type="checkbox"/>
	2.2	320		0,006 x d_1	<input type="checkbox"/>	<input checked="" type="checkbox"/>	<input type="checkbox"/>
	3.1	270		0,006 x d_1	<input type="checkbox"/>	<input checked="" type="checkbox"/>	<input type="checkbox"/>
	3.2	270		0,006 x d_1	<input type="checkbox"/>	<input checked="" type="checkbox"/>	<input type="checkbox"/>
	4.1	220		0,005 x d_1	<input type="checkbox"/>	<input checked="" type="checkbox"/>	<input type="checkbox"/>
	4.2	180		0,005 x d_1	<input type="checkbox"/>	<input checked="" type="checkbox"/>	<input type="checkbox"/>
非鉄 · Non-ferrous materials							
アルミニウム合金 · Aluminium alloys							
N	1.1						
	1.2						
	1.3						
	1.4						
	1.5						
	1.6						
	銅合金 · Copper alloys						
	2.1						
	2.2						
	2.3	320		0,008 x d_1	<input type="checkbox"/>	<input type="checkbox"/>	<input type="checkbox"/>
	2.4						<input checked="" type="checkbox"/>
	2.5						
	2.6	270		0,007 x d_1	<input type="checkbox"/>	<input type="checkbox"/>	<input type="checkbox"/>
	2.7						<input checked="" type="checkbox"/>
	2.8						
	マグネシウム合金 · Magnesium alloys						
3.1							
3.2							
合成樹脂 · Synthetics							
4.1							
4.2							
4.3							
4.4							
特殊合金 · Special materials							
5.1							
5.2							
5.3							
耐熱合金 · Special materials							
チタン合金 · Titanium alloys							
S	1.1						
	1.2	120		0,006 x d_1		<input type="checkbox"/>	
	1.3	70		0,005 x d_1		<input type="checkbox"/>	
	ニッケル基、コバルト基、鉄基合金 · Nickel alloys, cobalt alloys and iron alloys						
	2.1	110		0,006 x d_1		<input type="checkbox"/>	
	2.2	50		0,004 x d_1		<input type="checkbox"/>	
	2.3	40		0,004 x d_1		<input type="checkbox"/>	
	2.4	40		0,004 x d_1		<input type="checkbox"/>	
	2.5	30		0,004 x d_1		<input type="checkbox"/>	
	2.6	40		0,004 x d_1		<input type="checkbox"/>	
高硬度鋼 · Hard materials							
H	1.1	180		0,006 x d_1	<input type="checkbox"/>	<input checked="" type="checkbox"/>	
	1.2	160		0,005 x d_1	<input type="checkbox"/>	<input checked="" type="checkbox"/>	
	1.3	140		0,005 x d_1	<input type="checkbox"/>	<input checked="" type="checkbox"/>	
	1.4	110		0,004 x d_1	<input type="checkbox"/>	<input checked="" type="checkbox"/>	
	1.5	90		0,003 x d_1	<input type="checkbox"/>	<input checked="" type="checkbox"/>	

v_c = 切削速度 · Cutting speed
 f_z = 刃あたり送り · Feed per tooth

■ = 最適 · very suitable
□ = 適用可能 · suitable

- ハイパフォーマンスツール
- 最大12 x d₁ までの 5種類のネック長さ
- より厳しいR公差

- High performance tool
- 5 cylindrical neck lengths up to 12 x d₁ available
- High-precision corner radius

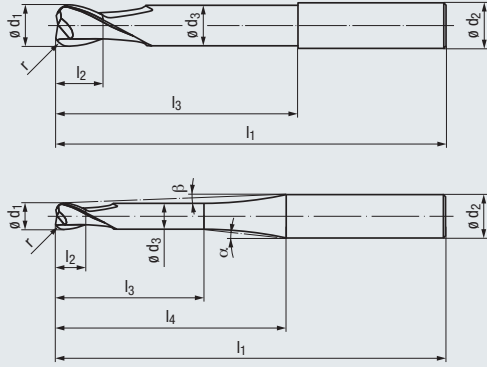

H

超硬

DIN 6535
HA
HB

30° **ラジアス**

1-3°

≤ 66 HRC



new



高硬度鋼

コーティング・Coating

アプリケーション - 被削材 (P4参照)

- 高硬度鋼加工用に新しく開発された特別な TIALN-コーティングを採用
- 立壁のあるキャビティの加工に
- HSC-高速仕上げ加工に最適

Applications - material (see page 4)

- Special TiAlN-coating for machining hardened materials
- For milling of cylindrical cavities
- Suitable for HSC finishing

TIALN

P	3.1-5.1	1.1-2.1
K	1.1-4.2	
H	1.1-1.5	

l₃ = 3 x d₁ - ショート・Short design

製品型番・Order code

3867A

ø d ₁	r	l ₂	l ₃	l ₁	ø d ₃	l ₄	ø d ₂	α	β	Z (刃数)	サイズ 型番		
-0,015	±0,005												
0,5	0,05	0,5	1,5	57	0,45	8,5	6	22,5°	18,5°	2	.00050E	●	
0,5	0,1	0,5	1,5	57	0,45	8,5	6	22,5°	18,5°	2	.000501	●	
0,8	0,05	0,8	2,4	57	0,75	9	6	22,5°	17°	2	.00080E	●	
0,8	0,1	0,8	2,4	57	0,75	9	6	22,5°	17°	2	.000801	●	
1	0,05	1	3	57	0,95	9,5	6	22°	15,5°	2	.00100E	●	
1	0,1	1	3	57	0,95	9,5	6	22°	15,5°	2	.001001	●	
1	0,2	1	3	57	0,95	9,5	6	22°	15,5°	2	.001002	●	
1,2	0,1	1,2	3,6	57	1,1	10	6	21,5°	14°	2	.001201	●	
1,2	0,3	1,2	3,6	57	1,1	10	6	21,5°	14°	2	.001203	●	
1,5	0,1	1,25	4,5	57	1,4	10,5	6	21,5°	12,5°	2	.001501	●	
1,5	0,3	1,25	4,5	57	1,4	10,5	6	21,5°	12,5°	2	.001503	●	
1,8	0,1	1,5	5,4	57	1,7	11	6	21,5°	11,5°	2	.001801	●	
1,8	0,3	1,5	5,4	57	1,7	11	6	21,5°	11,5°	2	.001803	●	
2	0,1	1,5	6	57	1,9	11,5	6	21°	10,5°	2	.002001	●	
2	0,3	1,5	6	57	1,9	11,5	6	21°	10,5°	2	.002003	●	
2	0,4	1,5	6	57	1,9	11,5	6	21°	10,5°	2	.002004	●	
2	0,5	1,5	6	57	1,9	11,5	6	21°	10,5°	2	.002005	●	
3	0,1	2	9	57	2,9	14,5	6	16,5°	6,5°	2	.003001	●	
3	0,3	2	9	57	2,9	14,5	6	16,5°	6,5°	2	.003003	●	
3	0,5	2	9	57	2,9	14,5	6	16,5°	6,5°	2	.003005	●	
4	0,1	2,5	12	57	3,9	16	6	15,5°	4°	2	.004001	●	
4	0,3	2,5	12	57	3,9	16	6	15,5°	4°	2	.004003	●	
4	0,5	2,5	12	57	3,9	16	6	15,5°	4°	2	.004005	●	
4	0,6	2,5	12	57	3,9	16	6	15,5°	4°	2	.004006	●	
5	0,1	3	15	57	4,9	18	6	11°	2°	2	.005001	●	
5	0,3	3	15	57	4,9	18	6	11°	2°	2	.005003	●	
5	0,5	3	15	57	4,9	18	6	11°	2°	2	.005005	●	
5	0,8	3	15	57	4,9	18	6	11°	2°	2	.005008	●	
6	0,3	3,5	20	57	5,9	-	6	-	-	2	.006003	●	
6	0,5	3,5	20	57	5,9	-	6	-	-	2	.006005	●	
6	1	3,5	20	57	5,9	-	6	-	-	2	.006010	●	



超硬ソリッド ラジラスエンドミル - ショート (2 枚刃)
Solid carbide torus end mills - short design (2 flutes)

H

$l_3 = 3 \times d_1$

荒加工
Roughing

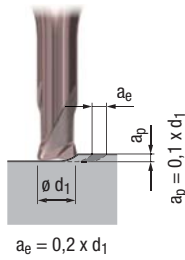

中仕上げ加工
Pre-finishing

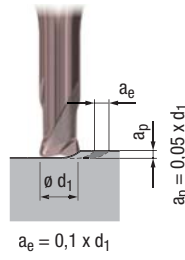

仕上げ加工
Finishing

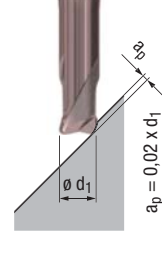

対象製品 · Valid for
3867A

	切削速度 v_c [m/min]	刃あたり送り f_z [mm]	切削速度 v_c [m/min]	刃あたり送り f_z [mm]	切削速度 v_c [m/min]	刃あたり送り f_z [mm]
--	-----------------------	----------------------	-----------------------	----------------------	-----------------------	----------------------



鋼 · Steel materials											
P	1.1	260	$0,013 \times d_1$	320	$0,015 \times d_1$	360	$0,013 \times d_1$	<input type="checkbox"/>	<input checked="" type="checkbox"/>	<input type="checkbox"/>	<input checked="" type="checkbox"/>
	2.1	240	$0,012 \times d_1$	280	$0,014 \times d_1$	320	$0,012 \times d_1$	<input type="checkbox"/>	<input checked="" type="checkbox"/>	<input type="checkbox"/>	<input checked="" type="checkbox"/>
	3.1	220	$0,011 \times d_1$	240	$0,013 \times d_1$	280	$0,011 \times d_1$	<input type="checkbox"/>	<input checked="" type="checkbox"/>	<input type="checkbox"/>	<input type="checkbox"/>
	4.1	200	$0,010 \times d_1$	220	$0,012 \times d_1$	240	$0,010 \times d_1$	<input type="checkbox"/>	<input checked="" type="checkbox"/>	<input type="checkbox"/>	<input type="checkbox"/>
	5.1	180	$0,009 \times d_1$	200	$0,010 \times d_1$	220	$0,009 \times d_1$	<input type="checkbox"/>	<input checked="" type="checkbox"/>	<input type="checkbox"/>	<input type="checkbox"/>
ステンレス · Stainless steel materials											
M	1.1										
	2.1										
	3.1										
	4.1										
鋳鉄 · Cast materials											
K	1.1	260	$0,011 \times d_1$	320	$0,013 \times d_1$	360	$0,010 \times d_1$	<input type="checkbox"/>	<input checked="" type="checkbox"/>	<input type="checkbox"/>	<input type="checkbox"/>
	1.2	260	$0,011 \times d_1$	320	$0,013 \times d_1$	360	$0,010 \times d_1$	<input type="checkbox"/>	<input checked="" type="checkbox"/>	<input type="checkbox"/>	<input type="checkbox"/>
	2.1	240	$0,011 \times d_1$	280	$0,013 \times d_1$	320	$0,010 \times d_1$	<input type="checkbox"/>	<input checked="" type="checkbox"/>	<input type="checkbox"/>	<input type="checkbox"/>
	2.2	240	$0,011 \times d_1$	280	$0,013 \times d_1$	320	$0,010 \times d_1$	<input type="checkbox"/>	<input checked="" type="checkbox"/>	<input type="checkbox"/>	<input type="checkbox"/>
	3.1	220	$0,010 \times d_1$	240	$0,011 \times d_1$	270	$0,008 \times d_1$	<input type="checkbox"/>	<input checked="" type="checkbox"/>	<input type="checkbox"/>	<input type="checkbox"/>
	3.2	220	$0,010 \times d_1$	240	$0,011 \times d_1$	270	$0,008 \times d_1$	<input type="checkbox"/>	<input checked="" type="checkbox"/>	<input type="checkbox"/>	<input type="checkbox"/>
	4.1	200	$0,008 \times d_1$	220	$0,009 \times d_1$	240	$0,007 \times d_1$	<input type="checkbox"/>	<input checked="" type="checkbox"/>	<input type="checkbox"/>	<input type="checkbox"/>
4.2	180	$0,008 \times d_1$	200	$0,009 \times d_1$	220	$0,007 \times d_1$	<input type="checkbox"/>	<input checked="" type="checkbox"/>	<input type="checkbox"/>	<input type="checkbox"/>	
非鉄 · Non-ferrous materials											
アルミニウム合金 · Aluminium alloys											
N	1.1										
	1.2										
	1.3										
	1.4										
	1.5										
	1.6										
	銅合金 · Copper alloys										
	2.1										
	2.2										
	2.3										
	2.4										
	2.5										
	2.6										
	2.7										
	2.8										
	マグネシウム合金 · Magnesium alloys										
3.1											
3.2											
合成樹脂 · Synthetics											
4.1											
4.2											
4.3											
4.4											
特殊合金 · Special materials											
5.1											
5.2											
5.3											
耐熱合金 · Special materials											
チタン合金 · Titanium alloys											
S	1.1										
	1.2										
	1.3										
	ニッケル基、コバルト基、鉄基合金 · Nickel alloys, cobalt alloys and iron alloys										
	2.1										
	2.2										
	2.3										
2.4											
2.5											
2.6											
高硬度鋼 · Hard materials											
H	1.1	160	$0,008 \times d_1$	200	$0,009 \times d_1$	220	$0,009 \times d_1$	<input type="checkbox"/>	<input checked="" type="checkbox"/>	<input type="checkbox"/>	<input type="checkbox"/>
	1.2	120	$0,007 \times d_1$	180	$0,008 \times d_1$	200	$0,008 \times d_1$	<input type="checkbox"/>	<input checked="" type="checkbox"/>	<input type="checkbox"/>	<input type="checkbox"/>
	1.3			160	$0,008 \times d_1$	180	$0,008 \times d_1$	<input type="checkbox"/>	<input checked="" type="checkbox"/>	<input type="checkbox"/>	<input type="checkbox"/>
	1.4			140	$0,007 \times d_1$	160	$0,007 \times d_1$	<input type="checkbox"/>	<input checked="" type="checkbox"/>	<input type="checkbox"/>	<input type="checkbox"/>
	1.5			120	$0,006 \times d_1$	140	$0,006 \times d_1$	<input type="checkbox"/>	<input checked="" type="checkbox"/>	<input type="checkbox"/>	<input type="checkbox"/>

v_c = 切削速度 · Cutting speed
 f_z = 刃あたり送り · Feed per tooth

■ = 最適 · very suitable
□ = 適用可能 · suitable

- ハイパフォーマンスツール
- 最大12 x d₁ までの 5種類のネック長さ
- より厳しいR公差

- High performance tool
- 5 cylindrical neck lengths up to 12 x d₁ available
- High-precision corner radius

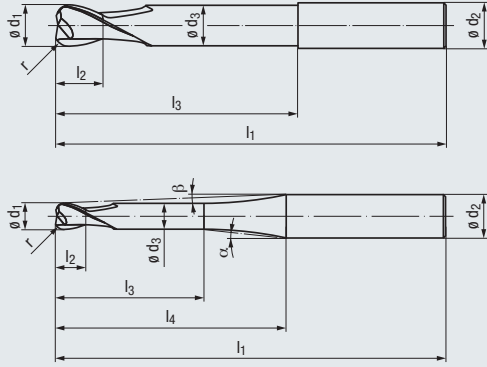

H

超硬

DIN 6535
HA
HB

new

30° **ラジアス**

1-3°

≤ 66 HRC



高硬度鋼

コーティング・Coating

アプリケーション - 被削材 (P4参照)

- 高硬度鋼加工用に新しく開発された特別な TIALN-コーティングを採用
- 立壁のあるキャビティの加工に
- HSC-高速仕上げ加工に最適

Applications – material (see page 4)

- Special TiAlN-coating for machining hardened materials
- For milling of cylindrical cavities
- Suitable for HSC finishing

TIALN

P	3.1-5.1	1.1-2.1
K	1.1-4.2	
H	1.1-1.5	

l₃ = 5 x d₁ - ロング・Long design

製品型番・Order code

∅ d ₁	r	l ₂	l ₃	l ₁	∅ d ₃	l ₄	∅ d ₂	α	β	Z (刃数)	サイズ 型番	3868A
-0,015	±0,005											
0,5	0,05	0,5	2,5	57	0,45	9,5	6	22,5°	17°	2	.00050E	●
0,5	0,1	0,5	2,5	57	0,45	9,5	6	22,5°	17°	2	.000501	●
0,8	0,05	0,8	4	57	0,75	10,5	6	22,5°	14,5°	2	.00080E	●
0,8	0,1	0,8	4	57	0,75	10,5	6	22,5°	14,5°	2	.000801	●
1	0,05	1	5	57	0,95	11,5	6	22°	13°	2	.00100E	●
1	0,1	1	5	57	0,95	11,5	6	22°	13°	2	.001001	●
1	0,2	1	5	57	0,95	11,5	6	22°	13°	2	.001002	●
1,2	0,1	1,2	6	57	1,1	12	6	22,5°	12°	2	.001201	●
1,2	0,3	1,2	6	57	1,1	12	6	22,5°	12°	2	.001203	●
1,5	0,1	1,25	7,5	57	1,4	13,5	6	21,5°	10°	2	.001501	●
1,5	0,3	1,25	7,5	57	1,4	13,5	6	21,5°	10°	2	.001503	●
1,8	0,1	1,5	9	57	1,7	14	6	24°	9°	2	.001801	●
1,8	0,3	1,5	9	57	1,7	14	6	24°	9°	2	.001803	●
2	0,1	1,5	10	57	1,9	14	6	28°	9°	2	.002001	●
2	0,3	1,5	10	57	1,9	14	6	28°	9°	2	.002003	●
2	0,4	1,5	10	57	1,9	14	6	28°	9°	2	.002004	●
2	0,5	1,5	10	57	1,9	14	6	28°	9°	2	.002005	●
3	0,1	2	15	57	2,9	20,5	6	16,5°	5°	2	.003001	●
3	0,3	2	15	57	2,9	20,5	6	16,5°	5°	2	.003003	●
3	0,5	2	15	57	2,9	20,5	6	16,5°	5°	2	.003005	●
4	0,1	2,5	20	63	3,9	24	6	15,5°	3°	2	.004001	●
4	0,3	2,5	20	63	3,9	24	6	15,5°	3°	2	.004003	●
4	0,5	2,5	20	63	3,9	24	6	15,5°	3°	2	.004005	●
4	0,6	2,5	20	63	3,9	24	6	15,5°	3°	2	.004006	●
5	0,1	3	25	72	4,9	35	6	4°	1,5°	2	.005001	●
5	0,3	3	25	72	4,9	35	6	4°	1,5°	2	.005003	●
5	0,5	3	25	72	4,9	35	6	4°	1,5°	2	.005005	●
5	0,8	3	25	72	4,9	35	6	4°	1,5°	2	.005008	●
6	0,3	3,5	30	72	5,9	-	6	-	-	2	.006003	●
6	0,5	3,5	30	72	5,9	-	6	-	-	2	.006005	●
6	1	3,5	30	72	5,9	-	6	-	-	2	.006010	●



超硬ソリッド ラジラスエンドミル - ロング (2 枚刃)
Solid carbide torus end mills – long design (2 flutes)

H

$l_3 = 5 \times d_1$

荒加工
Roughing

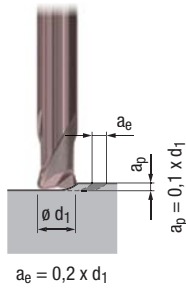

中仕上げ加工
Pre-finishing

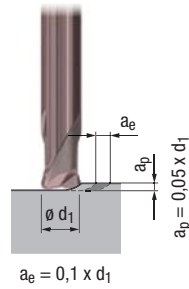

仕上げ加工
Finishing

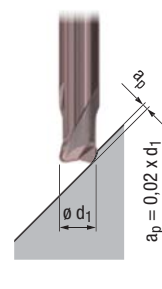

対象製品 · Valid for
3868A

		切削速度 v_c [m/min]	刃あたり送り f_z [mm]	切削速度 v_c [m/min]	刃あたり送り f_z [mm]	切削速度 v_c [m/min]	刃あたり送り f_z [mm]			MMS MQL		
鋼 · Steel materials												
P	1.1	240	$0,013 \times d_1$	300	$0,015 \times d_1$	340	$0,013 \times d_1$	<input type="checkbox"/>	<input checked="" type="checkbox"/>	<input type="checkbox"/>	<input checked="" type="checkbox"/>	
	2.1	220	$0,012 \times d_1$	260	$0,014 \times d_1$	340	$0,012 \times d_1$	<input type="checkbox"/>	<input checked="" type="checkbox"/>	<input type="checkbox"/>	<input checked="" type="checkbox"/>	
	3.1	200	$0,011 \times d_1$	220	$0,013 \times d_1$	260	$0,011 \times d_1$	<input type="checkbox"/>	<input checked="" type="checkbox"/>	<input type="checkbox"/>	<input type="checkbox"/>	
	4.1	180	$0,010 \times d_1$	200	$0,012 \times d_1$	220	$0,010 \times d_1$	<input type="checkbox"/>	<input checked="" type="checkbox"/>	<input type="checkbox"/>	<input type="checkbox"/>	
	5.1	160	$0,009 \times d_1$	180	$0,010 \times d_1$	200	$0,009 \times d_1$	<input type="checkbox"/>	<input checked="" type="checkbox"/>	<input type="checkbox"/>	<input type="checkbox"/>	
ステンレス · Stainless steel materials												
M	1.1											
	2.1											
	3.1											
	4.1											
鋳鉄 · Cast materials												
K	1.1	240	$0,011 \times d_1$	300	$0,013 \times d_1$	340	$0,010 \times d_1$	<input type="checkbox"/>	<input checked="" type="checkbox"/>	<input type="checkbox"/>	<input type="checkbox"/>	
	1.2	240	$0,011 \times d_1$	300	$0,013 \times d_1$	340	$0,010 \times d_1$	<input type="checkbox"/>	<input checked="" type="checkbox"/>	<input type="checkbox"/>	<input type="checkbox"/>	
	2.1	220	$0,011 \times d_1$	260	$0,013 \times d_1$	300	$0,010 \times d_1$	<input type="checkbox"/>	<input checked="" type="checkbox"/>	<input type="checkbox"/>	<input type="checkbox"/>	
	2.2	220	$0,011 \times d_1$	260	$0,013 \times d_1$	300	$0,010 \times d_1$	<input type="checkbox"/>	<input checked="" type="checkbox"/>	<input type="checkbox"/>	<input type="checkbox"/>	
	3.1	200	$0,010 \times d_1$	220	$0,011 \times d_1$	250	$0,008 \times d_1$	<input type="checkbox"/>	<input checked="" type="checkbox"/>	<input type="checkbox"/>	<input type="checkbox"/>	
	3.2	200	$0,010 \times d_1$	220	$0,011 \times d_1$	250	$0,008 \times d_1$	<input type="checkbox"/>	<input checked="" type="checkbox"/>	<input type="checkbox"/>	<input type="checkbox"/>	
	4.1	180	$0,008 \times d_1$	200	$0,009 \times d_1$	220	$0,007 \times d_1$	<input type="checkbox"/>	<input checked="" type="checkbox"/>	<input type="checkbox"/>	<input type="checkbox"/>	
4.2	160	$0,008 \times d_1$	180	$0,009 \times d_1$	200	$0,007 \times d_1$	<input type="checkbox"/>	<input checked="" type="checkbox"/>	<input type="checkbox"/>	<input type="checkbox"/>		
非鉄 · Non-ferrous materials												
アルミニウム合金 · Aluminium alloys												
N	1.1											
	1.2											
	1.3											
	1.4											
	1.5											
	1.6											
	銅合金 · Copper alloys											
	2.1											
	2.2											
	2.3											
	2.4											
	2.5											
	2.6											
	2.7											
	2.8											
	マグネシウム合金 · Magnesium alloys											
3.1												
3.2												
合成樹脂 · Synthetics												
4.1												
4.2												
4.3												
4.4												
特殊合金 · Special materials												
5.1												
5.2												
5.3												
耐熱合金 · Special materials												
チタン合金 · Titanium alloys												
S	1.1											
	1.2											
	1.3											
	ニッケル基、コバルト基、鉄基合金 · Nickel alloys, cobalt alloys and iron alloys											
	2.1											
	2.2											
	2.3											
2.4												
2.5												
2.6												
高硬度鋼 · Hard materials												
H	1.1	140	$0,008 \times d_1$	180	$0,009 \times d_1$	200	$0,009 \times d_1$	<input type="checkbox"/>	<input checked="" type="checkbox"/>	<input type="checkbox"/>	<input type="checkbox"/>	
	1.2	110	$0,007 \times d_1$	160	$0,008 \times d_1$	180	$0,008 \times d_1$	<input type="checkbox"/>	<input checked="" type="checkbox"/>	<input type="checkbox"/>	<input type="checkbox"/>	
	1.3			140	$0,008 \times d_1$	160	$0,008 \times d_1$	<input type="checkbox"/>	<input checked="" type="checkbox"/>	<input type="checkbox"/>	<input type="checkbox"/>	
	1.4			130	$0,007 \times d_1$	140	$0,007 \times d_1$	<input type="checkbox"/>	<input checked="" type="checkbox"/>	<input type="checkbox"/>	<input type="checkbox"/>	
	1.5			110	$0,006 \times d_1$	130	$0,006 \times d_1$	<input type="checkbox"/>	<input checked="" type="checkbox"/>	<input type="checkbox"/>	<input type="checkbox"/>	

v_c = 切削速度 · Cutting speed
 f_z = 刃あたり送り · Feed per tooth

■ = 最適 · very suitable
□ = 適用可能 · suitable

- ハイパフォーマンスツール
- 最大12 x d₁ までの 5種類のネック長さ
- より厳しいR公差

- High performance tool
- 5 cylindrical neck lengths up to 12 x d₁ available
- High-precision corner radius

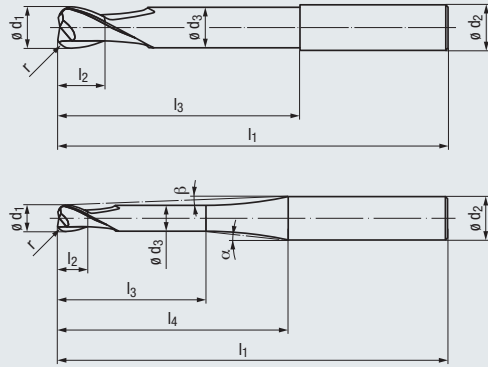

H

超硬

DIN 6535
HA
HB

ラジラス

30°

1-3°

≤ 66 HRC



new



高硬度鋼

コーティング · Coating

アプリケーション - 被削材 (P4参照)

- 高硬度鋼加工用に新しく開発された特別な TIALN-コーティングを採用
- 立壁のあるキャビティの加工に
- HSC-高速仕上げ加工に最適

Applications - material (see page 4)

- Special TiAlN-coating for machining hardened materials
- For milling of cylindrical cavities
- Suitable for HSC finishing

TIALN

P	3.1-5.1	1.1-2.1
K	1.1-4.2	
H	1.1-1.5	

l₃ = 8 x d₁ - エクストラロング · Extra long design

製品型番 · Order code

∅ d ₁	r	l ₂	l ₃	l ₁	∅ d ₃	l ₄	∅ d ₂	α	β	Z (刃数)	サイズ型番	3869A
-0,015	±0,005											
0,5	0,05	0,5	4	57	0,45	11	6	22,5°	14,5°	2	.00050E	●
0,5	0,1	0,5	4	57	0,45	11	6	22,5°	14,5°	2	.000501	●
0,8	0,05	0,8	6,4	57	0,75	13	6	22,5°	12°	2	.00080E	●
0,8	0,1	0,8	6,4	57	0,75	13	6	22,5°	12°	2	.000801	●
1	0,05	1	8	57	0,95	14,5	6	22°	10,5°	2	.00100E	●
1	0,1	1	8	57	0,95	14,5	6	22°	10,5°	2	.001001	●
1	0,2	1	8	57	0,95	14,5	6	22°	10,5°	2	.001002	●
1,2	0,1	1,2	9,6	57	1,1	16	6	21,5°	9°	2	.001201	●
1,2	0,3	1,2	9,6	57	1,1	16	6	21,5°	9°	2	.001203	●
1,5	0,1	1,25	12	57	1,4	18	6	21,5°	8°	2	.001501	●
1,5	0,3	1,25	12	57	1,4	18	6	21,5°	8°	2	.001503	●
1,8	0,1	1,5	14,4	57	1,7	20	6	21,5°	6,5°	2	.001801	●
1,8	0,3	1,5	14,4	57	1,7	20	6	21,5°	6,5°	2	.001803	●
2	0,1	1,5	16	57	1,9	20	6	28°	6,5°	2	.002001	●
2	0,3	1,5	16	57	1,9	20	6	28°	6,5°	2	.002003	●
2	0,4	1,5	16	57	1,9	20	6	28°	6,5°	2	.002004	●
2	0,5	1,5	16	57	1,9	20	6	28°	6,5°	2	.002005	●
3	0,1	2	24	68	2,9	30	6	15°	3,5°	2	.003001	●
3	0,3	2	24	68	2,9	30	6	15°	3,5°	2	.003003	●
3	0,5	2	24	68	2,9	30	6	15°	3,5°	2	.003005	●
4	0,1	2,5	32	80	3,9	42	6	6°	2°	2	.004001	●
4	0,3	2,5	32	80	3,9	42	6	6°	2°	2	.004003	●
4	0,5	2,5	32	80	3,9	42	6	6°	2°	2	.004005	●
4	0,6	2,5	32	80	3,9	42	6	6°	2°	2	.004006	●
5	0,1	3	40	80	4,9	43	6	11°	1,5°	2	.005001	●
5	0,3	3	40	80	4,9	43	6	11°	1,5°	2	.005003	●
5	0,5	3	40	80	4,9	43	6	11°	1,5°	2	.005005	●
5	0,8	3	40	80	4,9	43	6	11°	1,5°	2	.005008	●
6	0,3	3,5	48	86	5,9	-	6	-	-	2	.006003	●
6	0,5	3,5	48	86	5,9	-	6	-	-	2	.006005	●
6	1	3,5	48	86	5,9	-	6	-	-	2	.006010	●



超硬ソリッド ラジアスエンドミル – エクストラロング (2 枚刃)
Solid carbide torus end mills – extra long design (2 flutes)

H

$$l_3 = 8 \times d_1$$

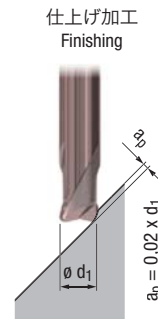
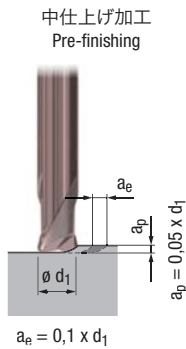

対象製品 · Valid for
3869A

	切削速度 v_c [m/min]	刃あたり送り f_z [mm]	切削速度 v_c [m/min]	刃あたり送り f_z [mm]					
鋼 · Steel materials									
P	1.1	240	$0.013 \times d_1$	280	$0.013 \times d_1$	<input type="checkbox"/>	<input checked="" type="checkbox"/>	<input type="checkbox"/>	
	2.1	220	$0.012 \times d_1$	260	$0.012 \times d_1$	<input type="checkbox"/>	<input checked="" type="checkbox"/>	<input type="checkbox"/>	
	3.1	200	$0.011 \times d_1$	240	$0.011 \times d_1$	<input type="checkbox"/>	<input checked="" type="checkbox"/>	<input type="checkbox"/>	
	4.1	180	$0.010 \times d_1$	210	$0.010 \times d_1$	<input type="checkbox"/>	<input checked="" type="checkbox"/>	<input type="checkbox"/>	
	5.1	160	$0.009 \times d_1$	190	$0.009 \times d_1$	<input type="checkbox"/>	<input checked="" type="checkbox"/>	<input type="checkbox"/>	
ステンレス · Stainless steel materials									
M	1.1								
	2.1								
	3.1								
	4.1								
鋳鉄 · Cast materials									
K	1.1	240	$0.011 \times d_1$	280	$0.010 \times d_1$	<input type="checkbox"/>	<input checked="" type="checkbox"/>	<input type="checkbox"/>	
	1.2	240	$0.011 \times d_1$	280	$0.010 \times d_1$	<input type="checkbox"/>	<input checked="" type="checkbox"/>	<input type="checkbox"/>	
	2.1	220	$0.011 \times d_1$	260	$0.010 \times d_1$	<input type="checkbox"/>	<input checked="" type="checkbox"/>	<input type="checkbox"/>	
	2.2	220	$0.011 \times d_1$	260	$0.010 \times d_1$	<input type="checkbox"/>	<input checked="" type="checkbox"/>	<input type="checkbox"/>	
	3.1	200	$0.010 \times d_1$	240	$0.008 \times d_1$	<input type="checkbox"/>	<input checked="" type="checkbox"/>	<input type="checkbox"/>	
	3.2	200	$0.010 \times d_1$	240	$0.008 \times d_1$	<input type="checkbox"/>	<input checked="" type="checkbox"/>	<input type="checkbox"/>	
	4.1	180	$0.008 \times d_1$	210	$0.007 \times d_1$	<input type="checkbox"/>	<input checked="" type="checkbox"/>	<input type="checkbox"/>	
	4.2	160	$0.008 \times d_1$	190	$0.007 \times d_1$	<input type="checkbox"/>	<input checked="" type="checkbox"/>	<input type="checkbox"/>	
非鉄 · Non-ferrous materials									
アルミニウム合金 · Aluminium alloys									
N	1.1								
	1.2								
	1.3								
	1.4								
	1.5								
	1.6								
	銅合金 · Copper alloys								
	2.1								
	2.2								
	2.3								
	2.4								
	2.5								
	2.6								
	2.7								
	2.8								
	マグネシウム合金 · Magnesium alloys								
3.1									
3.2									
合成樹脂 · Synthetics									
4.1									
4.2									
4.3									
4.4									
特殊合金 · Special materials									
5.1									
5.2									
5.3									
耐熱合金 · Special materials									
チタン合金 · Titanium alloys									
S	1.1								
	1.2								
	1.3								
	ニッケル基、コバルト基、鉄基合金 · Nickel alloys, cobalt alloys and iron alloys								
	2.1								
	2.2								
	2.3								
2.4									
2.5									
2.6									
高硬度鋼 · Hard materials									
H	1.1	140	$0.008 \times d_1$	180	$0.009 \times d_1$	<input type="checkbox"/>	<input checked="" type="checkbox"/>	<input type="checkbox"/>	
	1.2	120	$0.007 \times d_1$	160	$0.008 \times d_1$	<input type="checkbox"/>	<input checked="" type="checkbox"/>	<input type="checkbox"/>	
	1.3	110	$0.008 \times d_1$	140	$0.008 \times d_1$	<input type="checkbox"/>	<input checked="" type="checkbox"/>	<input type="checkbox"/>	
	1.4	100	$0.007 \times d_1$	120	$0.007 \times d_1$	<input type="checkbox"/>	<input checked="" type="checkbox"/>	<input type="checkbox"/>	
	1.5	80	$0.006 \times d_1$	100	$0.006 \times d_1$	<input type="checkbox"/>	<input checked="" type="checkbox"/>	<input type="checkbox"/>	

v_c = 切削速度 · Cutting speed
 f_z = 刃あたり送り · Feed per tooth

■ = 最適 · very suitable
□ = 適用可能 · suitable

- ハイパフォーマンスツール
- 最大12 x d₁ までの 5種類のネック長さ
- より厳しいR公差

- High performance tool
- 5 cylindrical neck lengths up to 12 x d₁ available
- High-precision corner radius

H

超硬

DIN 6535
HA
HB

30° ラジラス

1-3°

≤ 66 HRC



new



高硬度鋼

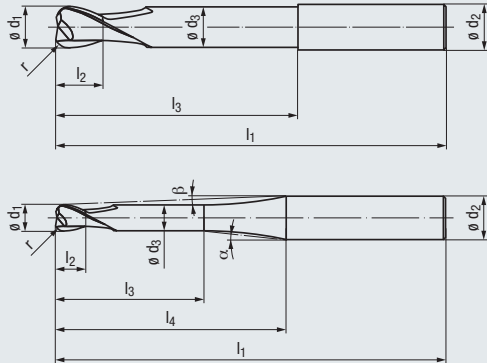

コーティング · Coating

アプリケーション - 被削材 (P4参照)

- 高硬度鋼加工用に新しく開発された特別な TiAlN-コーティングを採用
- 立壁のあるキャビティの加工に
- HSC-高速仕上げ加工に最適

Applications - material (see page 4)

- Special TiAlN-coating for machining hardened materials
- For milling of cylindrical cavities
- Suitable for HSC finishing

TiAlN

P	3.1-5.1	1.1-2.1
K	1.1-4.2	
H	1.1-1.5	

l₃ = 10 x d₁ - エクストラロング · Extra long design

製品型番 · Order code

ø d ₁	r	l ₂	l ₃	l ₁	ø d ₃	l ₄	ø d ₂ h5	α	β	Z (刃数)	サイズ 型番	3870A
-0,015	±0,005											
0,5	0,05	0,5	5	57	0,45	12	6	22,5°	13,5°	2	.00050E	●
0,5	0,1	0,5	5	57	0,45	12	6	22,5°	13,5°	2	.000501	●
0,8	0,05	0,8	8	57	0,75	14,5	6	22,5°	11°	2	.00080E	●
0,8	0,1	0,8	8	57	0,75	14,5	6	22,5°	11°	2	.000801	●
1	0,05	1	10	57	0,95	16,5	6	22°	9,5°	2	.00100E	●
1	0,1	1	10	57	0,95	16,5	6	22°	9,5°	2	.001001	●
1	0,2	1	10	57	0,95	16,5	6	22°	9,5°	2	.001002	●
1,2	0,1	1,2	12	57	1,1	18,5	6	21°	8°	2	.001201	●
1,2	0,3	1,2	12	57	1,1	18,5	6	21°	8°	2	.001203	●
1,5	0,1	1,25	15	57	1,4	20	6	25,5°	7°	2	.001501	●
1,5	0,3	1,25	15	57	1,4	20	6	25,5°	7°	2	.001503	●
1,8	0,1	1,5	18	63	1,7	22	6	28,5°	6°	2	.001801	●
1,8	0,3	1,5	18	63	1,7	22	6	28,5°	6°	2	.001803	●
2	0,1	1,5	20	63	1,9	24	6	28°	5,5°	2	.002001	●
2	0,3	1,5	20	63	1,9	24	6	28°	5,5°	2	.002003	●
2	0,4	1,5	20	63	1,9	24	6	28°	5,5°	2	.002004	●
2	0,5	1,5	20	63	1,9	24	6	28°	5,5°	2	.002005	●
3	0,1	2	30	72	2,9	35	6	18°	3°	2	.003001	●
3	0,3	2	30	72	2,9	35	6	18°	3°	2	.003003	●
3	0,5	2	30	72	2,9	35	6	18°	3°	2	.003005	●
4	0,1	2,5	40	80	3,9	44	6	15,5°	2°	2	.004001	●
4	0,3	2,5	40	80	3,9	44	6	15,5°	2°	2	.004003	●
4	0,5	2,5	40	80	3,9	44	6	15,5°	2°	2	.004005	●
4	0,6	2,5	40	80	3,9	44	6	15,5°	2°	2	.004006	●
5	0,1	3	50	100	4,9	53	6	11°	1°	2	.005001	●
5	0,3	3	50	100	4,9	53	6	11°	1°	2	.005003	●
5	0,5	3	50	100	4,9	53	6	11°	1°	2	.005005	●
5	0,8	3	50	100	4,9	53	6	11°	1°	2	.005008	●
6	0,3	3,5	60	100	5,9	-	6	-	-	2	.006003	●
6	0,5	3,5	60	100	5,9	-	6	-	-	2	.006005	●
6	1	3,5	60	100	5,9	-	6	-	-	2	.006010	●



超硬ソリッド ラジアスエンドミル – エクストラロング (2 枚刃)
Solid carbide torus end mills – extra long design (2 flutes)

H

$l_3 = 10 \times d_1$

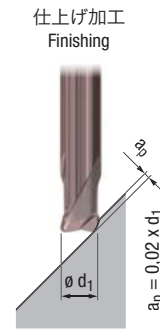
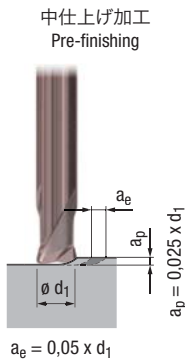

対象製品 · Valid for
3870A

	切削速度 v_c [m/min]	刃あたり送り f_z [mm]	切削速度 v_c [m/min]	刃あたり送り f_z [mm]			MMS MQL		
鋼 · Steel materials									
P	1.1	240	$0,013 \times d_1$	280	$0,013 \times d_1$	<input type="checkbox"/>	<input checked="" type="checkbox"/>	<input type="checkbox"/>	
	2.1	220	$0,012 \times d_1$	260	$0,012 \times d_1$	<input type="checkbox"/>	<input checked="" type="checkbox"/>	<input type="checkbox"/>	
	3.1	200	$0,011 \times d_1$	240	$0,011 \times d_1$	<input type="checkbox"/>	<input checked="" type="checkbox"/>	<input type="checkbox"/>	
	4.1	180	$0,010 \times d_1$	210	$0,010 \times d_1$	<input type="checkbox"/>	<input checked="" type="checkbox"/>	<input type="checkbox"/>	
	5.1	160	$0,009 \times d_1$	190	$0,009 \times d_1$	<input type="checkbox"/>	<input checked="" type="checkbox"/>	<input type="checkbox"/>	
ステンレス · Stainless steel materials									
M	1.1								
	2.1								
	3.1								
	4.1								
鋳鉄 · Cast materials									
K	1.1	240	$0,011 \times d_1$	280	$0,010 \times d_1$	<input type="checkbox"/>	<input checked="" type="checkbox"/>	<input type="checkbox"/>	
	1.2	240	$0,011 \times d_1$	280	$0,010 \times d_1$	<input type="checkbox"/>	<input checked="" type="checkbox"/>	<input type="checkbox"/>	
	2.1	220	$0,011 \times d_1$	260	$0,010 \times d_1$	<input type="checkbox"/>	<input checked="" type="checkbox"/>	<input type="checkbox"/>	
	2.2	220	$0,011 \times d_1$	260	$0,010 \times d_1$	<input type="checkbox"/>	<input checked="" type="checkbox"/>	<input type="checkbox"/>	
	3.1	200	$0,010 \times d_1$	240	$0,008 \times d_1$	<input type="checkbox"/>	<input checked="" type="checkbox"/>	<input type="checkbox"/>	
	3.2	200	$0,010 \times d_1$	240	$0,008 \times d_1$	<input type="checkbox"/>	<input checked="" type="checkbox"/>	<input type="checkbox"/>	
	4.1	180	$0,008 \times d_1$	210	$0,007 \times d_1$	<input type="checkbox"/>	<input checked="" type="checkbox"/>	<input type="checkbox"/>	
	4.2	160	$0,008 \times d_1$	190	$0,007 \times d_1$	<input type="checkbox"/>	<input checked="" type="checkbox"/>	<input type="checkbox"/>	
非鉄 · Non-ferrous materials									
アルミニウム合金 · Aluminium alloys									
N	1.1								
	1.2								
	1.3								
	1.4								
	1.5								
	1.6								
	銅合金 · Copper alloys								
	2.1								
	2.2								
	2.3								
	2.4								
	2.5								
	2.6								
	2.7								
	2.8								
	マグネシウム合金 · Magnesium alloys								
3.1									
3.2									
合成樹脂 · Synthetics									
4.1									
4.2									
4.3									
4.4									
特殊合金 · Special materials									
5.1									
5.2									
5.3									
耐熱合金 · Special materials									
チタン合金 · Titanium alloys									
S	1.1								
	1.2								
	1.3								
	ニッケル基、コバルト基、鉄基合金 · Nickel alloys, cobalt alloys and iron alloys								
	2.1								
	2.2								
	2.3								
2.4									
2.5									
2.6									
高硬度鋼 · Hard materials									
H	1.1	140	0,008	180	0,009	<input type="checkbox"/>	<input checked="" type="checkbox"/>	<input type="checkbox"/>	
	1.2	120	0,007	160	0,008	<input type="checkbox"/>	<input checked="" type="checkbox"/>	<input type="checkbox"/>	
	1.3	110	0,008	140	0,008	<input type="checkbox"/>	<input checked="" type="checkbox"/>	<input type="checkbox"/>	
	1.4	100	0,007	120	0,007	<input type="checkbox"/>	<input checked="" type="checkbox"/>	<input type="checkbox"/>	
	1.5	80	0,006	100	0,006	<input type="checkbox"/>	<input checked="" type="checkbox"/>	<input type="checkbox"/>	

v_c = 切削速度 · Cutting speed
 f_z = 刃あたり送り · Feed per tooth

■ = 最適 · very suitable
□ = 適用可能 · suitable

- ハイパフォーマンスツール
- 最大12 x d₁ までの 5種類のネック長さ
- より厳しいR公差

- High performance tool
- 5 cylindrical neck lengths up to 12 x d₁ available
- High-precision corner radius

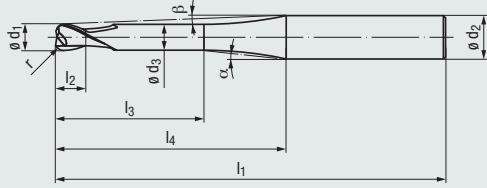
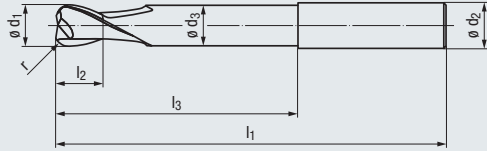

H

超硬

DIN 6535
HA
HB

30° ラジラス

1-3°

≤ 66 HRC



new



高硬度鋼

コーティング・Coating

アプリケーション - 被削材 (P4参照)

- 高硬度鋼加工用に新しく開発された特別な TiAlN-コーティングを採用
- 最大 12 x d₁ までの立壁のあるキャビティの加工に
- HSC-高速仕上げ加工に最適

Applications - material (see page 4)

- Special TiAlN-coating for machining hardened materials
- Milling of cylindrical cavities up to 12 x d₁
- Suitable for HSC finishing

TiAlN

P	3.1-5.1	1.1-2.1
K	1.1-4.2	
H	1.1-1.5	

l₃ = 12 x d₁ - エクストラロング・Extra long design

製品型番・Order code

∅ d ₁ -0,015	r ±0,005	l ₂	l ₃	l ₁	∅ d ₃	l ₄	∅ d ₂ h5	α	β	Z (刃数)	サイズ 型番	3871A
0,5	0,05	0,5	6	57	0,45	13	6	22,5°	12,5°	2	.00050E	●
0,5	0,1	0,5	6	57	0,45	13	6	22,5°	12,5°	2	.000501	●
0,8	0,05	0,8	9,6	57	0,75	16	6	23°	10°	2	.00080E	●
0,8	0,1	0,8	9,6	57	0,75	16	6	23°	10°	2	.000801	●
1	0,05	1	12	57	0,95	18,5	6	22°	8,5°	2	.00100E	●
1	0,1	1	12	57	0,95	18,5	6	22°	8,5°	2	.001001	●
1	0,2	1	12	57	0,95	18,5	6	22°	8,5°	2	.001002	●
1,2	0,1	1,2	14,4	57	1,1	21	6	21°	7°	2	.001201	●
1,2	0,3	1,2	14,4	57	1,1	21	6	21°	7°	2	.001203	●
1,5	0,1	1,25	18	63	1,4	24	6	21,5°	6°	2	.001501	●
1,5	0,3	1,25	18	63	1,4	24	6	21,5°	6°	2	.001503	●
1,8	0,1	1,5	21,6	66	1,7	26	6	28°	5,5°	2	.001801	●
1,8	0,3	1,5	21,6	66	1,7	26	6	28°	5,5°	2	.001803	●
2	0,1	1,5	24	66	1,9	28	6	28°	4,5°	2	.002001	●
2	0,3	1,5	24	66	1,9	28	6	28°	4,5°	2	.002003	●
2	0,4	1,5	24	66	1,9	28	6	28°	4,5°	2	.002004	●
2	0,5	1,5	24	66	1,9	28	6	28°	4,5°	2	.002005	●
3	0,1	2	36	80	2,9	42,5	6	14°	2,5°	2	.003001	●
3	0,3	2	36	80	2,9	42,5	6	14°	2,5°	2	.003003	●
3	0,5	2	36	80	2,9	42,5	6	14°	2,5°	2	.003005	●
4	0,1	2,5	48	100	3,9	61	6	5,5°	1,5°	2	.004001	●
4	0,3	2,5	48	100	3,9	61	6	5,5°	1,5°	2	.004003	●
4	0,5	2,5	48	100	3,9	61	6	5,5°	1,5°	2	.004005	●
4	0,6	2,5	48	100	3,9	61	6	5,5°	1,5°	2	.004006	●
5	0,1	3	60	100	4,9	63	6	11°	1°	2	.005001	●
5	0,3	3	60	100	4,9	63	6	11°	1°	2	.005003	●
5	0,5	3	60	100	4,9	63	6	11°	1°	2	.005005	●
5	0,8	3	60	100	4,9	63	6	11°	1°	2	.005008	●
6	0,3	3,5	72	110	5,9	-	6	-	-	2	.006003	●
6	0,5	3,5	72	110	5,9	-	6	-	-	2	.006005	●
6	1	3,5	72	110	5,9	-	6	-	-	2	.006010	●



超硬ソリッド ラジアスエンドミル – エクストラロング (2 枚刃)
Solid carbide torus end mills – extra long design (2 flutes)

H

$l_3 = 12 \times d_1$

中仕上げ加工
Pre-finishing

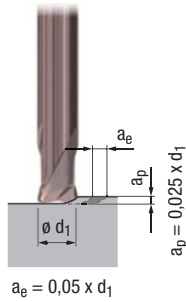

仕上げ加工
Finishing

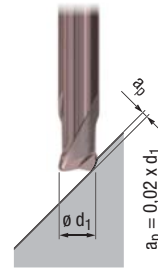

対象製品 · Valid for
3871A

切削速度 v_c [m/min]	刃あたり送り f_z [mm]	切削速度 v_c [m/min]	刃あたり送り f_z [mm]
-----------------------	----------------------	-----------------------	----------------------



鋼 · Steel materials					<input type="checkbox"/>	<input checked="" type="checkbox"/>	<input type="checkbox"/>	<input checked="" type="checkbox"/>	
P	1.1	240	$0,013 \times d_1$	280	$0,013 \times d_1$	<input type="checkbox"/>	<input checked="" type="checkbox"/>	<input type="checkbox"/>	<input checked="" type="checkbox"/>
	2.1	220	$0,012 \times d_1$	260	$0,012 \times d_1$	<input type="checkbox"/>	<input checked="" type="checkbox"/>	<input type="checkbox"/>	<input checked="" type="checkbox"/>
	3.1	200	$0,011 \times d_1$	240	$0,011 \times d_1$	<input type="checkbox"/>	<input checked="" type="checkbox"/>	<input type="checkbox"/>	<input type="checkbox"/>
	4.1	180	$0,010 \times d_1$	210	$0,010 \times d_1$	<input type="checkbox"/>	<input checked="" type="checkbox"/>	<input type="checkbox"/>	<input type="checkbox"/>
	5.1	160	$0,009 \times d_1$	190	$0,009 \times d_1$	<input type="checkbox"/>	<input checked="" type="checkbox"/>	<input type="checkbox"/>	<input type="checkbox"/>
ステンレス · Stainless steel materials									
M	1.1								
	2.1								
	3.1								
	4.1								
鋳鉄 · Cast materials									
K	1.1	240	$0,011 \times d_1$	280	$0,010 \times d_1$	<input type="checkbox"/>	<input checked="" type="checkbox"/>	<input type="checkbox"/>	<input type="checkbox"/>
	1.2	240	$0,011 \times d_1$	280	$0,010 \times d_1$	<input type="checkbox"/>	<input checked="" type="checkbox"/>	<input type="checkbox"/>	<input type="checkbox"/>
	2.1	220	$0,011 \times d_1$	260	$0,010 \times d_1$	<input type="checkbox"/>	<input checked="" type="checkbox"/>	<input type="checkbox"/>	<input type="checkbox"/>
	2.2	220	$0,011 \times d_1$	260	$0,010 \times d_1$	<input type="checkbox"/>	<input checked="" type="checkbox"/>	<input type="checkbox"/>	<input type="checkbox"/>
	3.1	200	$0,010 \times d_1$	240	$0,008 \times d_1$	<input type="checkbox"/>	<input checked="" type="checkbox"/>	<input type="checkbox"/>	<input type="checkbox"/>
	3.2	200	$0,010 \times d_1$	240	$0,008 \times d_1$	<input type="checkbox"/>	<input checked="" type="checkbox"/>	<input type="checkbox"/>	<input type="checkbox"/>
	4.1	180	$0,008 \times d_1$	210	$0,007 \times d_1$	<input type="checkbox"/>	<input checked="" type="checkbox"/>	<input type="checkbox"/>	<input type="checkbox"/>
	4.2	160	$0,008 \times d_1$	190	$0,007 \times d_1$	<input type="checkbox"/>	<input checked="" type="checkbox"/>	<input type="checkbox"/>	<input type="checkbox"/>
非鉄 · Non-ferrous materials									
アルミニウム合金 · Aluminium alloys									
N	1.1								
	1.2								
	1.3								
	1.4								
	1.5								
	1.6								
	銅合金 · Copper alloys								
	2.1								
	2.2								
	2.3								
	2.4								
	2.5								
	2.6								
	2.7								
	2.8								
	マグネシウム合金 · Magnesium alloys								
3.1									
3.2									
合成樹脂 · Synthetics									
4.1									
4.2									
4.3									
4.4									
特殊合金 · Special materials									
5.1									
5.2									
5.3									
耐熱合金 · Special materials									
チタン合金 · Titanium alloys									
S	1.1								
	1.2								
	1.3								
	ニッケル基、コバルト基、鉄基合金 · Nickel alloys, cobalt alloys and iron alloys								
	2.1								
	2.2								
	2.3								
2.4									
2.5									
2.6									
高硬度鋼 · Hard materials									
H	1.1	140	$0,008 \times d_1$	180	$0,009 \times d_1$	<input type="checkbox"/>	<input checked="" type="checkbox"/>	<input type="checkbox"/>	<input type="checkbox"/>
	1.2	120	$0,007 \times d_1$	160	$0,008 \times d_1$	<input type="checkbox"/>	<input checked="" type="checkbox"/>	<input type="checkbox"/>	<input type="checkbox"/>
	1.3	110	$0,008 \times d_1$	140	$0,008 \times d_1$	<input type="checkbox"/>	<input checked="" type="checkbox"/>	<input type="checkbox"/>	<input type="checkbox"/>
	1.4	100	$0,007 \times d_1$	120	$0,007 \times d_1$	<input type="checkbox"/>	<input checked="" type="checkbox"/>	<input type="checkbox"/>	<input type="checkbox"/>
	1.5	80	$0,006 \times d_1$	100	$0,006 \times d_1$	<input type="checkbox"/>	<input checked="" type="checkbox"/>	<input type="checkbox"/>	<input type="checkbox"/>

v_c = 切削速度 · Cutting speed
 f_z = 刃あたり送り · Feed per tooth

■ = 最適 · very suitable
□ = 適用可能 · suitable

- ハイパフォーマンスツール
- 4 枚刃
- より厳しいR公差
- 剛性の高い短フルート設計
- 3種類の工具長さ

- High-performance tool
- With 4 flutes
- High-precision corner radius
- Short, stable flute length
- 3 length available

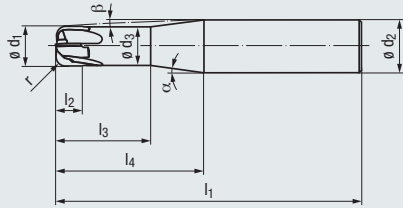
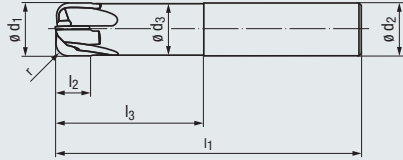

H

超硬

DIN 6535
HA
HB

new

0° **ラジアス**

1-3°

≤ 66 HRC



高硬度鋼

コーティング・Coating

アプリケーション - 被削材 (P4参照)

- 高硬度鋼加工用に新しく開発された特別な TIALN-コーティングを採用
- 極めて高い面粗さを要求される仕上げ加工に
- HSC-高速仕上げ加工に最適

Applications - material (see page 4)

- Special TiAlN-coating for machining hardened materials
- For finishing with very high surface quality
- Suitable for HSC finishing

TIALN

P	1.1-5.1
K	1.1-4.2
N	2.3, 2.6-2.8
N	2.2, 2.4-2.5
H	1.1-1.5

$l_3 = 3 \times d_1$ - ショート・Short design

製品型番・Order code

ϕd_1	r	l_2	l_3	l_1	ϕd_3	l_4	ϕd_2	α	β	Z (刃数)	サイズ 型番	3874A
-0,015	±0,005											
2	0,1	1,5	8	57	1,8	19,9	6	10°	6,5°	4	.002001	●
2	0,3	1,5	8	57	1,8	19,9	6	10°	6,5°	4	.002003	●
2	0,5	1,5	8	57	1,8	19,9	6	10°	6,5°	4	.002005	●
3	0,1	2	10	57	2,8	19	6	10°	5,5°	4	.003001	●
3	0,3	2	10	57	2,8	19	6	10°	5,5°	4	.003003	●
3	0,5	2	10	57	2,8	19	6	10°	5,5°	4	.003005	●
3	0,75	2	10	57	2,8	19	6	10°	5,5°	4	.003007	●
4	0,1	2,5	12	57	3,8	18,2	6	10°	3,5°	4	.004001	●
4	0,3	2,5	12	57	3,8	18,2	6	10°	3,5°	4	.004003	●
4	0,5	2,5	12	57	3,8	18,2	6	10°	3,5°	4	.004005	●
4	1	2,5	12	57	3,8	18,2	6	10°	3,5°	4	.004010	●
5	0,1	3	15	57	4,7	18,6	6	10°	2°	4	.005001	●
5	0,3	3	15	57	4,7	18,6	6	10°	2°	4	.005003	●
5	0,5	3	15	57	4,7	18,6	6	10°	2°	4	.005005	●
5	1,25	3	15	57	4,7	18,6	6	10°	2°	4	.005012	●
6	0,3	4	20	57	5,6	-	6	-	-	4	.006003	●
6	0,5	4	20	57	5,6	-	6	-	-	4	.006005	●
6	1	4	20	57	5,6	-	6	-	-	4	.006010	●
6	1,5	4	20	57	5,6	-	6	-	-	4	.006015	●
8	0,3	5	25	63	7,6	-	8	-	-	4	.008003	●
8	0,5	5	25	63	7,6	-	8	-	-	4	.008005	●
8	1	5	25	63	7,6	-	8	-	-	4	.008010	●
8	2	5	25	63	7,6	-	8	-	-	4	.008020	●
10	0,3	6	30	72	9,6	-	10	-	-	4	.010003	●
10	0,5	6	30	72	9,6	-	10	-	-	4	.010005	●
10	1	6	30	72	9,6	-	10	-	-	4	.010010	●
10	2	6	30	72	9,6	-	10	-	-	4	.010020	●
10	2,5	6	30	72	9,6	-	10	-	-	4	.010025	●
12	0,5	7	36	83	11,5	-	12	-	-	4	.012005	●
12	1	7	36	83	11,5	-	12	-	-	4	.012010	●
12	2	7	36	83	11,5	-	12	-	-	4	.012020	●
12	3	7	36	83	11,5	-	12	-	-	4	.012030	●
12	4	7	36	83	11,5	-	12	-	-	4	.012040	●
16	4	8	48	96	15,5	-	16	-	-	4	.016040	●



超硬ソリッド ラジラスエンドミル - ショート (4 枚刃)
Solid carbide torus end mills - short design (4 flutes)

H

$l_3 = 3 \times d_1$

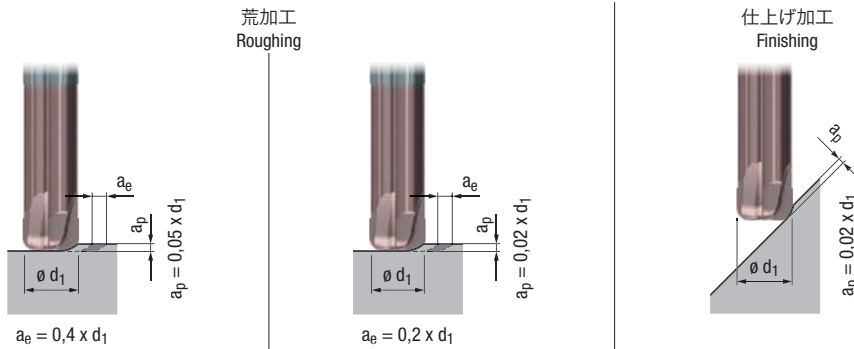

対象製品 · Valid for
3874A

		切削速度 v_c [m/min]	刃あたり送り f_z [mm]	切削速度 v_c [m/min]	刃あたり送り f_z [mm]	切削速度 v_c [m/min]	刃あたり送り f_z [mm]			MMS MQL	
鋼 · Steel materials											
P	1.1	280	$0,013 \times d_1$	320	$0,013 \times d_1$	360	$0,010 \times d_1$	<input type="checkbox"/>	<input checked="" type="checkbox"/>	<input type="checkbox"/>	<input checked="" type="checkbox"/>
	2.1	240	$0,012 \times d_1$	280	$0,012 \times d_1$	320	$0,009 \times d_1$	<input type="checkbox"/>	<input checked="" type="checkbox"/>	<input type="checkbox"/>	<input checked="" type="checkbox"/>
	3.1	210	$0,01 \times d_1$	240	$0,01 \times d_1$	270	$0,008 \times d_1$	<input type="checkbox"/>	<input checked="" type="checkbox"/>	<input type="checkbox"/>	<input type="checkbox"/>
	4.1	170	$0,009 \times d_1$	200	$0,009 \times d_1$	220	$0,007 \times d_1$	<input type="checkbox"/>	<input checked="" type="checkbox"/>	<input type="checkbox"/>	<input type="checkbox"/>
	5.1	140	$0,008 \times d_1$	160	$0,008 \times d_1$	180	$0,006 \times d_1$	<input type="checkbox"/>	<input checked="" type="checkbox"/>	<input type="checkbox"/>	<input type="checkbox"/>
ステンレス · Stainless steel materials											
M	1.1										
	2.1										
	3.1										
	4.1										
鋳鉄 · Cast materials											
K	1.1	280	$0,014 \times d_1$	320	$0,014 \times d_1$	360	$0,010 \times d_1$	<input type="checkbox"/>	<input checked="" type="checkbox"/>	<input type="checkbox"/>	<input type="checkbox"/>
	1.2	280	$0,014 \times d_1$	320	$0,014 \times d_1$	360	$0,010 \times d_1$	<input type="checkbox"/>	<input checked="" type="checkbox"/>	<input type="checkbox"/>	<input type="checkbox"/>
	2.1	250	$0,011 \times d_1$	280	$0,011 \times d_1$	320	$0,008 \times d_1$	<input type="checkbox"/>	<input checked="" type="checkbox"/>	<input type="checkbox"/>	<input type="checkbox"/>
	2.2	250	$0,011 \times d_1$	280	$0,011 \times d_1$	320	$0,008 \times d_1$	<input type="checkbox"/>	<input checked="" type="checkbox"/>	<input type="checkbox"/>	<input type="checkbox"/>
	3.1	210	$0,011 \times d_1$	240	$0,011 \times d_1$	270	$0,008 \times d_1$	<input type="checkbox"/>	<input checked="" type="checkbox"/>	<input type="checkbox"/>	<input type="checkbox"/>
	3.2	210	$0,011 \times d_1$	240	$0,011 \times d_1$	270	$0,008 \times d_1$	<input type="checkbox"/>	<input checked="" type="checkbox"/>	<input type="checkbox"/>	<input type="checkbox"/>
	4.1	170	$0,008 \times d_1$	200	$0,008 \times d_1$	220	$0,006 \times d_1$	<input type="checkbox"/>	<input checked="" type="checkbox"/>	<input type="checkbox"/>	<input type="checkbox"/>
	4.2	150	$0,008 \times d_1$	160	$0,008 \times d_1$	180	$0,006 \times d_1$	<input type="checkbox"/>	<input checked="" type="checkbox"/>	<input type="checkbox"/>	<input type="checkbox"/>
非鉄 · Non-ferrous materials											
アルミニウム合金 · Aluminium alloys											
	1.1										
	1.2										
	1.3										
	1.4										
	1.5										
	1.6										
銅合金 · Copper alloys											
N	2.1										
	2.2	250	$0,014 \times d_1$	280	$0,014 \times d_1$	320	$0,010 \times d_1$			<input type="checkbox"/>	<input checked="" type="checkbox"/>
	2.3	250	$0,014 \times d_1$	280	$0,014 \times d_1$	320	$0,010 \times d_1$	<input type="checkbox"/>	<input type="checkbox"/>	<input type="checkbox"/>	<input checked="" type="checkbox"/>
	2.4	210	$0,011 \times d_1$	240	$0,011 \times d_1$	270	$0,008 \times d_1$			<input type="checkbox"/>	<input checked="" type="checkbox"/>
	2.5	210	$0,011 \times d_1$	240	$0,011 \times d_1$	270	$0,008 \times d_1$			<input type="checkbox"/>	<input checked="" type="checkbox"/>
	2.6	210	$0,011 \times d_1$	240	$0,011 \times d_1$	270	$0,008 \times d_1$	<input type="checkbox"/>	<input type="checkbox"/>	<input type="checkbox"/>	<input checked="" type="checkbox"/>
	2.7	130	$0,008 \times d_1$	150	$0,008 \times d_1$	170	$0,006 \times d_1$			<input type="checkbox"/>	<input checked="" type="checkbox"/>
	2.8	130	$0,008 \times d_1$	150	$0,008 \times d_1$	170	$0,006 \times d_1$			<input type="checkbox"/>	<input checked="" type="checkbox"/>
マグネシウム合金 · Magnesium alloys											
	3.1										
	3.2										
合成樹脂 · Synthetics											
	4.1										
	4.2										
	4.3										
	4.4										
特殊合金 · Special materials											
	5.1										
	5.2										
	5.3										
耐熱合金 · Special materials											
チタン合金 · Titanium alloys											
	1.1										
	1.2										
	1.3										
S	ニッケル基、コバルト基、鉄基合金 · Nickel alloys, cobalt alloys and iron alloys										
	2.1										
	2.2										
	2.3										
	2.4										
	2.5										
	2.6										
高硬度鋼 · Hard materials											
H	1.1	130	$0,008 \times d_1$	150	$0,008 \times d_1$	180	$0,006 \times d_1$	<input type="checkbox"/>	<input checked="" type="checkbox"/>	<input type="checkbox"/>	<input type="checkbox"/>
	1.2	120	$0,007 \times d_1$	140	$0,007 \times d_1$	160	$0,005 \times d_1$	<input type="checkbox"/>	<input checked="" type="checkbox"/>	<input type="checkbox"/>	<input type="checkbox"/>
	1.3			120	$0,006 \times d_1$	140	$0,005 \times d_1$	<input type="checkbox"/>	<input checked="" type="checkbox"/>	<input type="checkbox"/>	<input type="checkbox"/>
	1.4			90	$0,005 \times d_1$	110	$0,004 \times d_1$	<input type="checkbox"/>	<input checked="" type="checkbox"/>	<input type="checkbox"/>	<input type="checkbox"/>
	1.5			70	$0,004 \times d_1$	90	$0,003 \times d_1$	<input type="checkbox"/>	<input checked="" type="checkbox"/>	<input type="checkbox"/>	<input type="checkbox"/>

v_c = 切削速度 · Cutting speed
 f_z = 刃あたり送り · Feed per tooth

■ = 最適 · very suitable
□ = 適用可能 · suitable

- ハイパフォーマンスツール
- 4 枚刃
- より厳しいR公差
- 剛性の高い短フルート設計
- 3種類の工具長さ

- High-performance tool
- With 4 flutes
- High-precision corner radius
- Short, stable flute length
- 3 length available

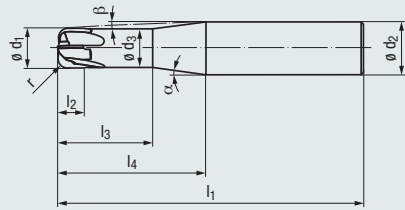
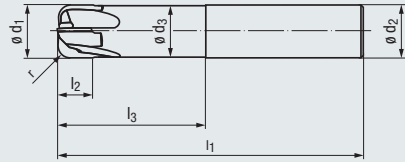

H

超硬

DIN 6535
HA
HB

0° ラジアス

1-3°

≤ 66
HRC



new



高硬度鋼

コーティング・Coating

アプリケーション - 被削材 (P4参照)

- 高硬度鋼加工用に新しく開発された特別な TIALN-コーティングを採用
- 極めて高い面粗さを要求される仕上げ加工に
- HSC-高速仕上げ加工に最適

Applications - material (see page 4)

- Special TiAlN-coating for machining hardened materials
- For finishing with very high surface quality
- Suitable for HSC finishing

TIALN

P	1.1-5.1
K	1.1-4.2
N	2.3, 2.6-2.8
N	2.2, 2.4-2.5
H	1.1-1.5

$l_3 = 5 \times d_1$ - ロング・Long design

製品型番・Order code

ϕd_1	r	l_2	l_3	l_1	ϕd_3	l_4	ϕd_2	α	β	Z (刃数)	サイズ 型番	3875A
-0,015	±0,005						h5					
2	0,1	1,5	10	63	1,8	21,9	6	10°	5,5°	4	.002001	●
2	0,3	1,5	10	63	1,8	21,9	6	10°	5,5°	4	.002003	●
2	0,5	1,5	10	63	1,8	21,9	6	10°	5,5°	4	.002005	●
3	0,1	2	15	63	2,8	24	6	10°	4°	4	.003001	●
3	0,3	2	15	63	2,8	24	6	10°	4°	4	.003003	●
3	0,5	2	15	63	2,8	24	6	10°	4°	4	.003005	●
4	0,1	2,5	20	63	3,8	26,2	6	10°	2,5°	4	.004001	●
4	0,3	2,5	20	63	3,8	26,2	6	10°	2,5°	4	.004003	●
4	0,5	2,5	20	63	3,8	26,2	6	10°	2,5°	4	.004005	●
5	0,1	3	25	66	4,7	28,6	6	10°	1,5°	4	.005001	●
5	0,3	3	25	66	4,7	28,6	6	10°	1,5°	4	.005003	●
5	0,5	3	25	66	4,7	28,6	6	10°	1,5°	4	.005005	●
6	0,3	4	30	66	5,6	-	6	-	-	4	.006003	●
6	0,5	4	30	66	5,6	-	6	-	-	4	.006005	●
6	1	4	30	66	5,6	-	6	-	-	4	.006010	●
6	1,5	4	30	66	5,6	-	6	-	-	4	.006015	●
8	0,3	5	40	78	7,6	-	8	-	-	4	.008003	●
8	0,5	5	40	78	7,6	-	8	-	-	4	.008005	●
8	1	5	40	78	7,6	-	8	-	-	4	.008010	●
8	2	5	40	78	7,6	-	8	-	-	4	.008020	●
10	0,3	6	50	92	9,6	-	10	-	-	4	.010003	●
10	0,5	6	50	92	9,6	-	10	-	-	4	.010005	●
10	1	6	50	92	9,6	-	10	-	-	4	.010010	●
10	2	6	50	92	9,6	-	10	-	-	4	.010020	●
10	2,5	6	50	92	9,6	-	10	-	-	4	.010025	●
12	0,5	7	60	106	11,5	-	12	-	-	4	.012005	●
12	1	7	60	106	11,5	-	12	-	-	4	.012010	●
12	2	7	60	106	11,5	-	12	-	-	4	.012020	●
12	3	7	60	106	11,5	-	12	-	-	4	.012030	●
12	4	7	60	106	11,5	-	12	-	-	4	.012040	●
16	4	8	80	130	15,5	-	16	-	-	4	.016040	●



超硬ソリッド ラジアスエンドミル - ロング (4 枚刃)
Solid carbide torus end mills – long design (4 flutes)

対象製品 · Valid for
3875A

H

$l_3 = 5 \times d_1$

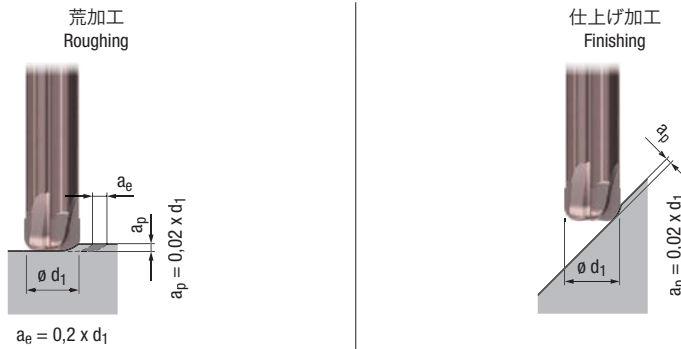

	切削速度 v_c [m/min]	刃あたり送り f_z [mm]	切削速度 v_c [m/min]	刃あたり送り f_z [mm]			MMS MQL		
鋼 · Steel materials									
P	1.1	320	$0,013 \times d_1$	360	$0,010 \times d_1$	<input type="checkbox"/>	<input checked="" type="checkbox"/>	<input type="checkbox"/>	
	2.1	280	$0,012 \times d_1$	320	$0,009 \times d_1$	<input type="checkbox"/>	<input checked="" type="checkbox"/>	<input type="checkbox"/>	
	3.1	240	$0,01 \times d_1$	270	$0,008 \times d_1$	<input type="checkbox"/>	<input checked="" type="checkbox"/>	<input type="checkbox"/>	
	4.1	200	$0,009 \times d_1$	220	$0,007 \times d_1$	<input type="checkbox"/>	<input checked="" type="checkbox"/>	<input type="checkbox"/>	
	5.1	160	$0,008 \times d_1$	180	$0,006 \times d_1$	<input type="checkbox"/>	<input checked="" type="checkbox"/>	<input type="checkbox"/>	
ステンレス · Stainless steel materials									
M	1.1								
	2.1								
	3.1								
	4.1								
鋳鉄 · Cast materials									
K	1.1	320	$0,014 \times d_1$	360	$0,010 \times d_1$	<input type="checkbox"/>	<input checked="" type="checkbox"/>	<input type="checkbox"/>	
	1.2	320	$0,014 \times d_1$	360	$0,010 \times d_1$	<input type="checkbox"/>	<input checked="" type="checkbox"/>	<input type="checkbox"/>	
	2.1	280	$0,011 \times d_1$	320	$0,008 \times d_1$	<input type="checkbox"/>	<input checked="" type="checkbox"/>	<input type="checkbox"/>	
	2.2	280	$0,011 \times d_1$	320	$0,008 \times d_1$	<input type="checkbox"/>	<input checked="" type="checkbox"/>	<input type="checkbox"/>	
	3.1	240	$0,011 \times d_1$	270	$0,008 \times d_1$	<input type="checkbox"/>	<input checked="" type="checkbox"/>	<input type="checkbox"/>	
	3.2	240	$0,011 \times d_1$	270	$0,008 \times d_1$	<input type="checkbox"/>	<input checked="" type="checkbox"/>	<input type="checkbox"/>	
	4.1	200	$0,008 \times d_1$	220	$0,006 \times d_1$	<input type="checkbox"/>	<input checked="" type="checkbox"/>	<input type="checkbox"/>	
	4.2	160	$0,008 \times d_1$	180	$0,006 \times d_1$	<input type="checkbox"/>	<input checked="" type="checkbox"/>	<input type="checkbox"/>	
非鉄 · Non-ferrous materials									
アルミニウム合金 · Aluminium alloys									
N	1.1								
	1.2								
	1.3								
	1.4								
	1.5								
	1.6								
	銅合金 · Copper alloys								
	2.1								
	2.2	280	$0,014 \times d_1$	320	$0,010 \times d_1$	<input type="checkbox"/>	<input type="checkbox"/>	<input type="checkbox"/>	
	2.3	280	$0,014 \times d_1$	320	$0,010 \times d_1$	<input type="checkbox"/>	<input type="checkbox"/>	<input type="checkbox"/>	
	2.4	240	$0,011 \times d_1$	270	$0,008 \times d_1$	<input type="checkbox"/>	<input type="checkbox"/>	<input type="checkbox"/>	
	2.5	240	$0,011 \times d_1$	270	$0,008 \times d_1$	<input type="checkbox"/>	<input type="checkbox"/>	<input type="checkbox"/>	
	2.6	240	$0,011 \times d_1$	270	$0,008 \times d_1$	<input type="checkbox"/>	<input type="checkbox"/>	<input type="checkbox"/>	
	2.7	150	$0,008 \times d_1$	170	$0,006 \times d_1$	<input type="checkbox"/>	<input type="checkbox"/>	<input type="checkbox"/>	
	2.8	150	$0,008 \times d_1$	170	$0,006 \times d_1$	<input type="checkbox"/>	<input type="checkbox"/>	<input type="checkbox"/>	
	マグネシウム合金 · Magnesium alloys								
3.1									
3.2									
合成樹脂 · Synthetics									
4.1									
4.2									
4.3									
4.4									
特殊合金 · Special materials									
5.1									
5.2									
5.3									
耐熱合金 · Special materials									
チタン合金 · Titanium alloys									
S	1.1								
	1.2								
	1.3								
	ニッケル基、コバルト基、鉄基合金 · Nickel alloys, cobalt alloys and iron alloys								
	2.1								
	2.2								
	2.3								
2.4									
2.5									
2.6									
高硬度鋼 · Hard materials									
H	1.1	150	$0,008 \times d_1$	180	$0,006 \times d_1$	<input type="checkbox"/>	<input checked="" type="checkbox"/>	<input type="checkbox"/>	
	1.2	140	$0,007 \times d_1$	160	$0,005 \times d_1$	<input type="checkbox"/>	<input checked="" type="checkbox"/>	<input type="checkbox"/>	
	1.3	120	$0,006 \times d_1$	140	$0,005 \times d_1$	<input type="checkbox"/>	<input checked="" type="checkbox"/>	<input type="checkbox"/>	
	1.4	90	$0,005 \times d_1$	110	$0,004 \times d_1$	<input type="checkbox"/>	<input checked="" type="checkbox"/>	<input type="checkbox"/>	
	1.5	70	$0,004 \times d_1$	90	$0,003 \times d_1$	<input type="checkbox"/>	<input checked="" type="checkbox"/>	<input type="checkbox"/>	

v_c = 切削速度 · Cutting speed
 f_z = 刃あたり送り · Feed per tooth

■ = 最適 · very suitable
□ = 適用可能 · suitable

- ハイパフォーマンスツール
- 4 枚刃
- より厳しいR公差
- 剛性の高い短フルート設計
- 3 種類の工具長さ

- High-performance tool
- With 4 flutes
- High-precision corner radius
- Short, stable flute length
- 3 length available

H

超硬

DIN 6535
HA
HB

0° ラジラス

1-3°

≤ 66 HRC



new



高硬度鋼

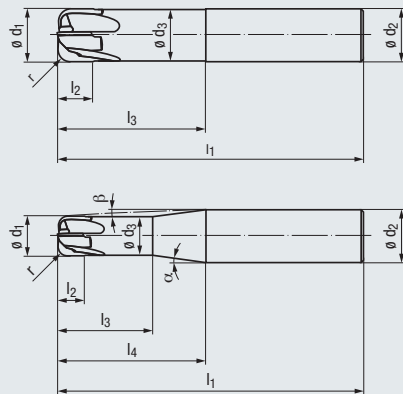

コーティング · Coating

アプリケーション - 被削材 (P4参照)

- 高硬度鋼加工用に新しく開発された特別な TIALN-コーティングを採用
- 極めて高い面粗さを要求される仕上げ加工に
- HSC-高速仕上げ加工に最適

Applications - material (see page 4)

- Special TIALN-coating for machining hardened materials
- For finishing with very high surface quality
- Suitable for HSC finishing

TIALN

P	1.1-5.1
K	1.1-4.2
N	2.3, 2.6-2.8
N	2.2, 2.4-2.5
H	1.1-1.5

l₃ = 8 x d₁ - エクストラロング · Extra long design

製品型番 · Order code

∅ d ₁ -0,015	r ±0,005	l ₂	l ₃	l ₁	∅ d ₃	l ₄	∅ d ₂ h5	α	β	Z (刃数)	サイズ 型番		
2	0,1	1,5	16	66	1,8	27,9	6	10°	4,5°	4	.002001	●	
2	0,3	1,5	16	66	1,8	27,9	6	10°	4,5°	4	.002003	●	
2	0,5	1,5	16	66	1,8	27,9	6	10°	4,5°	4	.002005	●	
3	0,1	2	24	72	2,8	33	6	10°	3°	4	.003001	●	
3	0,3	2	24	72	2,8	33	6	10°	3°	4	.003003	●	
3	0,5	2	24	72	2,8	33	6	10°	3°	4	.003005	●	
4	0,1	2,5	32	76	3,8	38,2	6	10°	2°	4	.004001	●	
4	0,3	2,5	32	76	3,8	38,2	6	10°	2°	4	.004003	●	
4	0,5	2,5	32	76	3,8	38,2	6	10°	2°	4	.004005	●	
5	0,1	3	40	80	4,7	43,6	6	10°	1°	4	.005001	●	
5	0,3	3	40	80	4,7	43,6	6	10°	1°	4	.005003	●	
5	0,5	3	40	80	4,7	43,6	6	10°	1°	4	.005005	●	
6	0,3	4	48	86	5,6	-	6	-	-	4	.006003	●	
6	0,5	4	48	86	5,6	-	6	-	-	4	.006005	●	
6	1	4	48	86	5,6	-	6	-	-	4	.006010	●	
8	0,3	5	64	102	7,6	-	8	-	-	4	.008003	●	
8	0,5	5	64	102	7,6	-	8	-	-	4	.008005	●	
8	1	5	64	102	7,6	-	8	-	-	4	.008010	●	
8	2	5	64	102	7,6	-	8	-	-	4	.008020	●	

3876A



超硬ソリッド ラジアスエンドミル – エキストラロング (4 枚刃)
Solid carbide torus end mills – extra long design (4 flutes)

対象製品 · Valid for
3876A

H

$l_3 = 8 \times d_1$

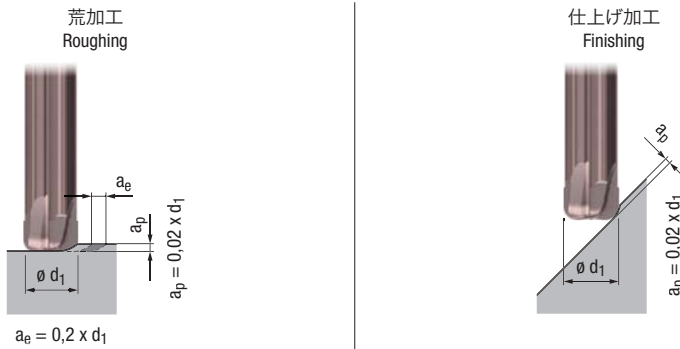

		切削速度 v_c [m/min]	刃あたり送り f_z [mm]	切削速度 v_c [m/min]	刃あたり送り f_z [mm]			MMS MQL		
鋼 · Steel materials										
P	1.1	250	$0,013 \times d_1$	300	$0,010 \times d_1$	<input type="checkbox"/>	<input checked="" type="checkbox"/>	<input type="checkbox"/>	<input checked="" type="checkbox"/>	
	2.1	230	$0,012 \times d_1$	260	$0,009 \times d_1$	<input type="checkbox"/>	<input checked="" type="checkbox"/>	<input type="checkbox"/>	<input checked="" type="checkbox"/>	
	3.1	200	$0,01 \times d_1$	230	$0,008 \times d_1$	<input type="checkbox"/>	<input checked="" type="checkbox"/>	<input type="checkbox"/>	<input type="checkbox"/>	
	4.1	170	$0,009 \times d_1$	200	$0,007 \times d_1$	<input type="checkbox"/>	<input checked="" type="checkbox"/>	<input type="checkbox"/>	<input type="checkbox"/>	
	5.1	150	$0,008 \times d_1$	180	$0,006 \times d_1$	<input type="checkbox"/>	<input checked="" type="checkbox"/>	<input type="checkbox"/>	<input type="checkbox"/>	
ステンレス · Stainless steel materials										
M	1.1									
	2.1									
	3.1									
	4.1									
鋳鉄 · Cast materials										
K	1.1	250	$0,014 \times d_1$	280	$0,010 \times d_1$	<input type="checkbox"/>	<input checked="" type="checkbox"/>	<input type="checkbox"/>	<input type="checkbox"/>	
	1.2	250	$0,014 \times d_1$	280	$0,010 \times d_1$	<input type="checkbox"/>	<input checked="" type="checkbox"/>	<input type="checkbox"/>	<input type="checkbox"/>	
	2.1	230	$0,011 \times d_1$	260	$0,008 \times d_1$	<input type="checkbox"/>	<input checked="" type="checkbox"/>	<input type="checkbox"/>	<input type="checkbox"/>	
	2.2	230	$0,011 \times d_1$	260	$0,008 \times d_1$	<input type="checkbox"/>	<input checked="" type="checkbox"/>	<input type="checkbox"/>	<input type="checkbox"/>	
	3.1	190	$0,011 \times d_1$	210	$0,008 \times d_1$	<input type="checkbox"/>	<input checked="" type="checkbox"/>	<input type="checkbox"/>	<input type="checkbox"/>	
	3.2	190	$0,011 \times d_1$	210	$0,008 \times d_1$	<input type="checkbox"/>	<input checked="" type="checkbox"/>	<input type="checkbox"/>	<input type="checkbox"/>	
	4.1	160	$0,008 \times d_1$	190	$0,006 \times d_1$	<input type="checkbox"/>	<input checked="" type="checkbox"/>	<input type="checkbox"/>	<input type="checkbox"/>	
	4.2	140	$0,008 \times d_1$	170	$0,006 \times d_1$	<input type="checkbox"/>	<input checked="" type="checkbox"/>	<input type="checkbox"/>	<input type="checkbox"/>	
非鉄 · Non-ferrous materials										
アルミニウム合金 · Aluminium alloys										
N	1.1									
	1.2									
	1.3									
	1.4									
	1.5									
	1.6									
	銅合金 · Copper alloys									
	2.1									
	2.2	240	$0,014 \times d_1$	280	$0,010 \times d_1$			<input type="checkbox"/>	<input checked="" type="checkbox"/>	
	2.3	240	$0,014 \times d_1$	280	$0,010 \times d_1$	<input type="checkbox"/>	<input type="checkbox"/>	<input type="checkbox"/>	<input checked="" type="checkbox"/>	
	2.4	200	$0,011 \times d_1$	250	$0,008 \times d_1$			<input type="checkbox"/>	<input checked="" type="checkbox"/>	
	2.5	200	$0,011 \times d_1$	250	$0,008 \times d_1$			<input type="checkbox"/>	<input checked="" type="checkbox"/>	
	2.6	200	$0,011 \times d_1$	250	$0,008 \times d_1$	<input type="checkbox"/>	<input type="checkbox"/>	<input type="checkbox"/>	<input checked="" type="checkbox"/>	
	2.7	140	$0,008 \times d_1$	170	$0,006 \times d_1$			<input type="checkbox"/>	<input checked="" type="checkbox"/>	
	2.8	140	$0,008 \times d_1$	170	$0,006 \times d_1$			<input type="checkbox"/>	<input checked="" type="checkbox"/>	
	マグネシウム合金 · Magnesium alloys									
3.1										
3.2										
合成樹脂 · Synthetics										
4.1										
4.2										
4.3										
4.4										
特殊合金 · Special materials										
5.1										
5.2										
5.3										
耐熱合金 · Special materials										
チタン合金 · Titanium alloys										
1.1										
1.2										
1.3										
S	ニッケル基、コバルト基、鉄基合金 · Nickel alloys, cobalt alloys and iron alloys									
	2.1									
	2.2									
	2.3									
	2.4									
	2.5									
2.6										
高硬度鋼 · Hard materials										
H	1.1	120	$0,008 \times d_1$	150	$0,006 \times d_1$	<input type="checkbox"/>	<input checked="" type="checkbox"/>	<input type="checkbox"/>	<input type="checkbox"/>	
	1.2	100	$0,007 \times d_1$	130	$0,005 \times d_1$	<input type="checkbox"/>	<input checked="" type="checkbox"/>	<input type="checkbox"/>	<input type="checkbox"/>	
	1.3	90	$0,006 \times d_1$	110	$0,005 \times d_1$	<input type="checkbox"/>	<input checked="" type="checkbox"/>	<input type="checkbox"/>	<input type="checkbox"/>	
	1.4	80	$0,005 \times d_1$	90	$0,004 \times d_1$	<input type="checkbox"/>	<input checked="" type="checkbox"/>	<input type="checkbox"/>	<input type="checkbox"/>	
	1.5	70	$0,004 \times d_1$	80	$0,003 \times d_1$	<input type="checkbox"/>	<input checked="" type="checkbox"/>	<input type="checkbox"/>	<input type="checkbox"/>	

v_c = 切削速度 · Cutting speed
 f_z = 刃あたり送り · Feed per tooth

■ = 最適 · very suitable
□ = 適用可能 · suitable

- ハイパフォーマンスツール
- 6 枚刃と 8 枚刃
- より厳しいR公差
- 剛性の高い短フルート設計
- 2 種類の工具長さ

- High performance tool
- With 6 and 8 flutes
- High-precision corner radius
- Short, stable flute length
- 2 lengths available



高硬度鋼

高硬度鋼

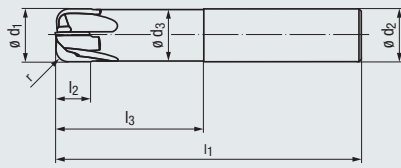

コーティング · Coating

アプリケーション - 被削材 (P4参照)

- 高硬度鋼の加工に
- 極めて高い面粗さを要求される仕上げ加工に
- HSC高速仕上げ加工に最適

Applications - material (see page 4)

- For machining hard materials
- For finishing with very high surface quality
- Suitable for HSC finishing

TIALN

TIALN

P	3.1-5.1	P	3.1-5.1
K	1.1-4.2	K	1.1-4.2
N	2.3, 2.6	N	2.3, 2.6
S	1.2-2.6	S	1.2-2.6
H	1.1-1.5	H	1.1-1.5

ショート · Short design

製品型番 · Order code

ϕd_1 $\pm 0,01$	r $\pm 0,005$	l_2	l_3	l_1	ϕd_3	ϕd_2 h5	Z (刃数)	サイズ 型番	2876A
10	1	6	30	72	9,6	10	6	.010010	●
10	2,5	6	30	72	9,6	10	6	.010	●
12	1	7	35	83	11,5	12	8	.012010	●
12	3	7	35	83	11,5	12	8	.012	●

ロング · Long design

製品型番 · Order code

ϕd_1 $\pm 0,01$	r $\pm 0,005$	l_2	l_3	l_1	ϕd_3	ϕd_2 h5	Z (刃数)	サイズ 型番	2877A
10	1	6	45	100	9,6	10	6	.010010	●
10	2,5	6	45	100	9,6	10	6	.010	●
12	1	7	50	100	11,5	12	8	.012010	●
12	3	7	50	100	11,5	12	8	.012	●
16	4	8	60	120	15,5	16	8	.016	●



超硬ソリッド ラジアスエンドミル - ショートおよびロング (6-8 枚刃)
Solid carbide torus end mills - short and long design (6-8 flutes)

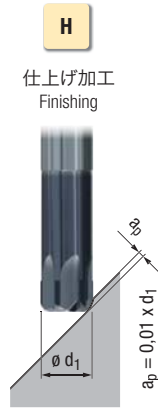

対象製品 · Valid for
2876A
2877A

		切削速度 v_c [m/min]	刃あたり送り f_z [mm]			MMS MQL		
鋼 · Steel materials								
P	1.1							
	2.1							
	3.1	270	$0,007 \times d_1$	<input type="checkbox"/>	<input checked="" type="checkbox"/>	<input type="checkbox"/>		
	4.1	220	$0,006 \times d_1$	<input type="checkbox"/>	<input checked="" type="checkbox"/>	<input type="checkbox"/>		
	5.1	180	$0,005 \times d_1$	<input type="checkbox"/>	<input checked="" type="checkbox"/>	<input type="checkbox"/>		
ステンレス · Stainless steel materials								
M	1.1							
	2.1							
	3.1							
	4.1							
鋳鉄 · Cast materials								
K	1.1	360	$0,008 \times d_1$	<input type="checkbox"/>	<input checked="" type="checkbox"/>		<input type="checkbox"/>	
	1.2	360	$0,008 \times d_1$	<input type="checkbox"/>	<input checked="" type="checkbox"/>		<input type="checkbox"/>	
	2.1	320	$0,006 \times d_1$	<input type="checkbox"/>	<input checked="" type="checkbox"/>		<input type="checkbox"/>	
	2.2	320	$0,006 \times d_1$	<input type="checkbox"/>	<input checked="" type="checkbox"/>		<input type="checkbox"/>	
	3.1	270	$0,006 \times d_1$	<input type="checkbox"/>	<input checked="" type="checkbox"/>		<input type="checkbox"/>	
	3.2	270	$0,006 \times d_1$	<input type="checkbox"/>	<input checked="" type="checkbox"/>		<input type="checkbox"/>	
	4.1	220	$0,005 \times d_1$	<input type="checkbox"/>	<input checked="" type="checkbox"/>		<input type="checkbox"/>	
	4.2	180	$0,005 \times d_1$	<input type="checkbox"/>	<input checked="" type="checkbox"/>		<input type="checkbox"/>	
非鉄 · Non-ferrous materials								
アルミニウム合金 · Aluminium alloys								
N	1.1							
	1.2							
	1.3							
	1.4							
	1.5							
	1.6							
	銅合金 · Copper alloys							
	2.1							
	2.2							
	2.3	320	$0,008 \times d_1$	<input type="checkbox"/>	<input type="checkbox"/>	<input type="checkbox"/>	<input checked="" type="checkbox"/>	
	2.4							
	2.5							
	2.6	270	$0,007 \times d_1$	<input type="checkbox"/>	<input type="checkbox"/>	<input type="checkbox"/>	<input checked="" type="checkbox"/>	
	2.7							
	2.8							
	マグネシウム合金 · Magnesium alloys							
3.1								
3.2								
合成樹脂 · Synthetics								
4.1								
4.2								
4.3								
4.4								
特殊合金 · Special materials								
5.1								
5.2								
5.3								
耐熱合金 · Special materials								
チタン合金 · Titanium alloys								
S	1.1							
	1.2	120	$0,006 \times d_1$			<input type="checkbox"/>	<input checked="" type="checkbox"/>	
	1.3	70	$0,005 \times d_1$			<input type="checkbox"/>	<input checked="" type="checkbox"/>	
	ニッケル基、コバルト基、鉄基合金 · Nickel alloys, cobalt alloys and iron alloys							
	2.1	110	$0,006 \times d_1$			<input type="checkbox"/>	<input checked="" type="checkbox"/>	
	2.2	50	$0,004 \times d_1$			<input type="checkbox"/>	<input checked="" type="checkbox"/>	
	2.3	40	$0,004 \times d_1$			<input type="checkbox"/>	<input checked="" type="checkbox"/>	
	2.4	40	$0,004 \times d_1$			<input type="checkbox"/>	<input checked="" type="checkbox"/>	
	2.5	30	$0,004 \times d_1$			<input type="checkbox"/>	<input checked="" type="checkbox"/>	
	2.6	40	$0,004 \times d_1$			<input type="checkbox"/>	<input checked="" type="checkbox"/>	
高硬度鋼 · Hard materials								
H	1.1	180	$0,006 \times d_1$	<input type="checkbox"/>	<input checked="" type="checkbox"/>			
	1.2	160	$0,005 \times d_1$	<input type="checkbox"/>	<input checked="" type="checkbox"/>			
	1.3	140	$0,005 \times d_1$	<input type="checkbox"/>	<input checked="" type="checkbox"/>			
	1.4	110	$0,004 \times d_1$	<input type="checkbox"/>	<input checked="" type="checkbox"/>			
	1.5	90	$0,003 \times d_1$	<input type="checkbox"/>	<input checked="" type="checkbox"/>			

v_c = 切削速度 · Cutting speed
 f_z = 刃あたり送り · Feed per tooth

■ = 最適 · very suitable
□ = 適用可能 · suitable

コールドエアノズルを使用することで切削ポイントの温度上昇を防ぎ、さらなる切削速度の向上や工具寿命の延長といった効果が期待できます。ドライ加工となるため刃先の損傷の原因となる熱亀裂を抑制し、結果的に最新コーティングの高い性能をフルに発揮することが可能となるためです。また細かい切くずを深いポケットや溝から確実に排出することで、突発的な工具の欠損を防ぎます。

コールドエアノズルの機能はボルテックスチューブの原理に基づいています。ふたつの相反する回転気流を発生することで熱交換を行うもので、圧縮エアに繋ぐだけで -40 °C もの冷却エアを供給することが可能となります。

Cooled air reduces temperatures in the cutting area, which in turn permits higher cutting speeds and longer tool life. This type of cooling enables modern coatings to achieve their full potential, as damage to the cutting edge resulting from thermal shock is avoided.

Moreover, the cold-air nozzle helps to remove the tiny chips produced in copy milling even from deep recesses or cavities.

The function of the cold-air nozzle is based on the principle of the vortex tube, in which two opposed, rotating air streams are generated (without any moving parts). The internal air stream exits from one end, in the form of useable cold air with a temperature as low as -40 °C. All that is required is a normal pressurised air connection.

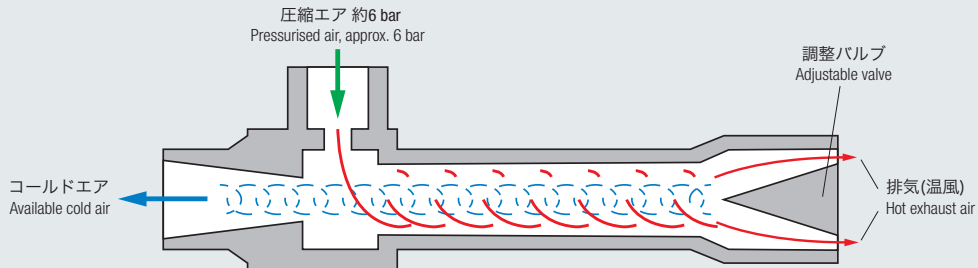

ボルテックスチューブ出口での温度 (ノズル先端ではありません)

Temperature, measured at the effective exit of the vortex tube (not the end of the nozzle)

供給エア圧 Supply air pressure [bar]	エア温度 °C とバルブ開放量の関係 Temperature of usable air in °C, with a cold air percentage of		
	25%	50%	75%
3	-31	-22	- 6
4	-35	-35	- 8
5	-39	-28	-10
6	-42	-31	-11
7	-46	-34	-13

供給エア温度 21 °C でのエア消費量

Air consumption, with supply air temperature of 21 °C

入力エア圧 Input pressure [bar]	エア消費量 Air consumption	容量 Capacity
6,9	7,08 l/s ; 25,5 m ³ /h	226 kcal/h ; 263 W

アプリケーション事例 :

コールドエア使用による工具寿命の延長

被削材: 高硬度金型鋼 K360 HRC63
加工内容: 金型の仕上げ加工
ツール: フランケン ハードカット ボール
工具径 Φ10, 2枚刃

切削条件: $v_c = 240 \text{ (m/min)} \cdot n = 7639 \text{ (min}^{-1}\text{)}$
 $f_z = 0,12 \text{ (mm/z)} \cdot v_f = 1833 \text{ (mm/min)}$
 $a_p = 0,2 \text{ (mm)} \cdot a_e = 0,2 \text{ (mm)}$

従来の工具寿命	コールドエア使用時の工具寿命
98 分	130 分

コールドエアを使用することで、工具寿命を 33% 延長

Application example:

Increased tool life using the cold-air nozzle

Workpiece: Hardened mould, material K360 with 63 HRC

Operation: Finishing the mould
Tool: FRANKEN Hard-Cut
Cutting diameter 10 mm, 2 flutes

Cutting conditions: $v_c = 240 \text{ m/min} \cdot n = 7639 \text{ rpm}$
 $f_z = 0.12 \text{ mm} \cdot v_f = 1833 \text{ mm/min}$
 $a_p = 0.2 \text{ mm} \cdot a_e = 0.2 \text{ mm}$

Tool life without coolant	Tool life with cold-air nozzle
98 minutes	130 minutes

By using the cold-air nozzle, it was possible to increase the tool life by 33%.



コールドエアノズル
Cold-Air Nozzle



コールドエアノズル付属品：

- フレキシブルホース (全長 300 mm)
- サイレンサー (SN14)
- 6mmインレットホース用口金付きボールバルブ (ST 1/4)
- クイックチェンジアタッチメント (7.2mm)

Delivery includes:

- With flexible hose (length approx. 300 mm) for cold air
- Silencer (SN14) for hot exhaust air
- Ball-valve with fitting (1/4") for inlet hose (6 mm) with quick-change attachment (7.2 mm)

製品型番・Order code		6910
全長 (ホース除く) Length (without hose)	サイズ 型番	
225 mm	.15	●

スペアホース
Spare Hose



製品型番・Order code		6910
全長 Length	サイズ 型番	
≈ 300 mm	.20	●
≈ 400 mm	.22	●
≈ 500 mm	.21	●

コールドエアノズル用ホルダー
Holders for the Cold-Air Nozzle



ソケット付き
ベーシックホルダー
Socket with basic holder



ソケット付き
マグネットスタンド
Socket with magnetic shoe



ソケット
Socket



ベーシックホルダー
Basic holder for socket



マグネットスタンド
Magnetic shoe for socket



製品型番・Order code		6910				
寸法 Dimensions	サイズ 型番					
ø 45 x 68 mm	.24	●				
ø 80 x 80 mm	.25		●			
ø 80 x 17 mm	.26					●
ø 32 x 63 mm	.27			●		
ø 45 x 20 mm	.32				●	

アタッチメントセット

Cold-Air Nozzle Attachment Set



製品型番・Order code		6910
	サイズ 型番	
	.12	●

同梱内容：

- 1 x ソケット付きベーシックホルダー (型番 : 6910.24)
- 1 x インレットホース 300 mm
- 1 x エルボー G 1/4
- 1 x スクリュー G 1/4
- 2 x シーリングプラグ G 1/4

Delivery includes:

- 1 x Socket with basic holder (art. No. 6910.24)
- 1 x Connecting hose 300 mm
- 1 x Elbow coupling G 1/4
- 1 x Screw G 1/4
- 2 x Sealing plugs G 1/4

コールドエアノズル アッセンブリセット 1

Cold-Air Nozzle Assembly Set 1



コールドエアノズル本体 (型番: 6910.15) とアタッチメントセット (型番: 6910.12)

Consists of 1 cold-air nozzle (art. no. 6910.15) and 1 cold-air nozzle attachment set (art. no. 6910.12)

製品型番・Order code		6910
	サイズ 型番	
	.11	●

Kaltluftdüsen-Montageset 2

Cold-Air Nozzle Assembly Set 2



製品型番・Order code		6910
	サイズ 型番	
	.10	●

コールドエアノズル本体 (型番: 6910.15) とアタッチメントセット (型番: 6910.12) 各2セット

Consists of 2 cold-air nozzles (art. no. 6910.15) and 2 cold-air nozzle attachment sets (art. no. 6910.12)

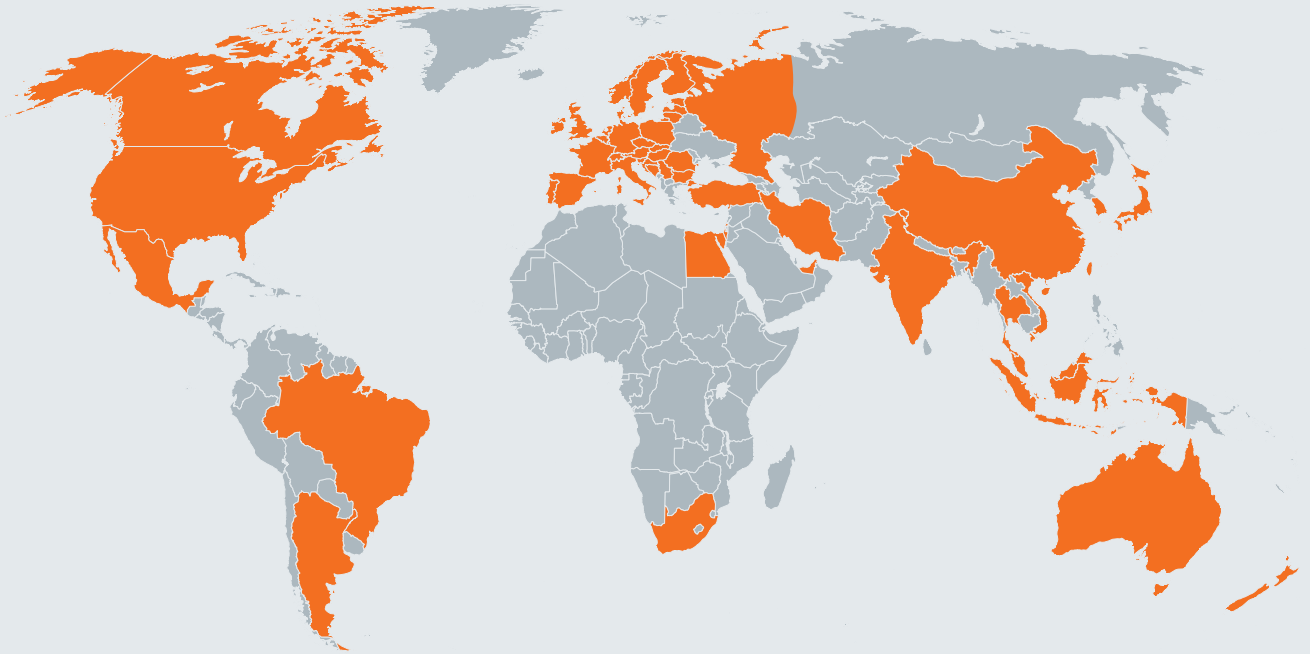

EMUGE-FRANKEN sales partners, please see www.emuge-franken.com/sales

EMUGE-Werk Richard Glimpel GmbH & Co. KG
Fabrik für Präzisionswerkzeuge

🏠 Nürnberger Straße 96-100
91207 Lauf
GERMANY

☎ +49 (0) 9123 / 186-0
📠 +49 (0) 9123 / 14313

FRANKEN GmbH & Co. KG
Fabrik für Präzisionswerkzeuge

🏠 Frankenstraße 7/9a
90607 Rückersdorf
GERMANY

☎ +49 (0) 911 / 9575-5
📠 +49 (0) 911 / 9575-327

✉ info@emuge-franken.com 🌐 www.emuge-franken.com



エムージェ・フランケン株式会社

🏠 224-0041
横浜市都筑区仲町台1-32-10-403

☎ +81 (0) 45-945-7831 / 📠 +81 (0) 45-945-7832

✉ info@emuge-franken.jp
🌐 www.emuge-franken.jp

